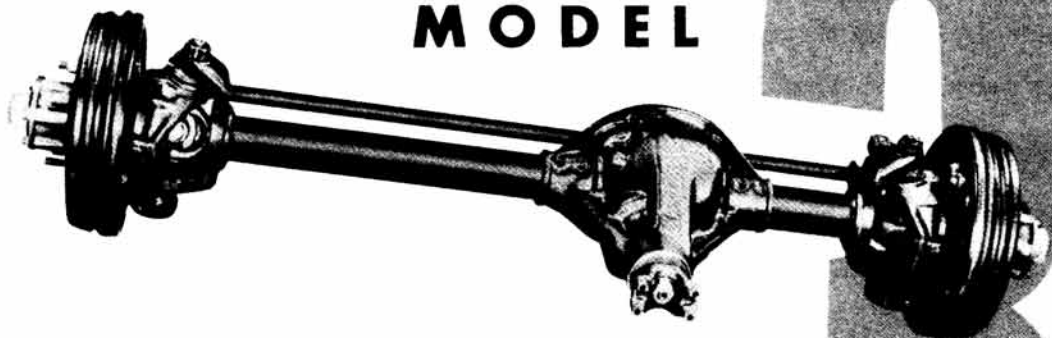


# SPICER<sup>®</sup> AXLE

## MAINTENANCE MANUAL

MODEL



330

FRONT AND REAR  
CARRIER TYPE



---

DRIVETRAIN SERVICE DIVISION  
P.O. BOX 321 • TOLEDO, OHIO 43691



DANA CORPORATION

# INDEX

	Page
<b>LUBRICATION</b> -----	<b>3</b>
<b>IDENTIFICATION OF SERVICE TOOLS</b> -----	<b>4-5</b>
<b>AXLE IDENTIFICATION</b> -----	<b>5</b>
<b>FRONT AXLES — WHEEL ENDS</b>	
<b>40° Steer Ball Socket</b> -----	<b>6-15</b>
<b>Closed Knuckle Design</b> -----	<b>15-18</b>
<b>REAR AXLES — WHEEL ENDS</b>	
<b>Unit Wheel Bearing (Lubricated with Hypoid Gear Lube)</b> -----	<b>19-21</b>
<b>Unit Wheel Bearing (Lubricated with Grease)</b> -----	<b>26-27</b>
<b>Unit Wheel Bearing Removal and Installation</b> -----	<b>24-27</b>
<b>AXLE CARRIER SECTION</b> -----	<b>27-41</b>

## IMPORTANT SAFETY NOTICE

Should an axle assembly require component parts replacement, it is recommended that "Original Equipment" replacement parts be used. They may be obtained through your local service dealer or other original equipment manufacturer parts supplier. **CAUTION: THE USE OF NON-ORIGINAL EQUIPMENT REPLACEMENT PARTS IS NOT RECOMMENDED AS THEIR USE MAY CAUSE UNIT FAILURE AND/OR AFFECT VEHICLE SAFETY.**

Proper service and repair is important to the safe, reliable operation of all motor vehicles or driving axles whether they be front or rear. The service procedures recommended and described in this service manual are effective methods for performing service operations. Some of these service operations require the use of tools specially designed for the purpose. The special tool should be used when and as recommended.

It is impossible to know, evaluate and advise the service trade of all conceivable ways in which service might be done or of the possible hazardous consequences of each way.

Accordingly, anyone who uses a service procedure or tool which is not recommended must first satisfy himself thoroughly that neither his safety or vehicle safety will be jeopardized by the service methods he selects.

## NOTE

Throughout this manual, reference is made to certain tool numbers whenever special tools are required. These numbers are numbers of the Miller Special Tools, 32615 Park Lane, Garden City, Michigan 48135. They are used herein for customer convenience only. Dana Corporation makes no warranty or representation with respect to these tools.

## LUBRICATION

It is not our intent to recommend any particular brand or make of lubricant for Spicer axles. However, a S.A.E. 90 weight multipurpose gear lubricant meeting Mil. Spec. L-2105-B, or 80 W 90 multipurpose gear lubricant meeting Mil. Spec. L-2105-C, and suitable for A.P.I. Service Classification GL-5 is suggested as a minimum requirement.

### IMPORTANT

As special equipment, limited slip differentials are provided in many vehicles, the freedom from "chatter" is a function of the lubricant used and cannot be covered in the above specifications. In some applications, a special limited slip differential lubricant may be required. If required, these special lubricants are normally available through the original equipment manufacturer.

### WHEEL BEARING LUBRICATION

Wheel bearings are lubricated by either grease packing the wheel bearing itself, or it can be lubricated from the hypoid gear lube in the housing.

For grease packing it is recommended that a number 2 consistency, lithium base 12 hydroxy stearate grease containing an E.P. additive be used. Such a lubricant would pass a load-carrying test at 40 pounds minimum with base oil pour point at  $-10^{\circ}$  F. maximum.

Wheel bearings which depend on lubrication from the hypoid gear lube in the axle housing, it is recommended that a S.A.E. 90 multipurpose gear lube meeting Mil. Spec. L-2105-B be used.

### CLOSED WHEEL END STEERING KNUCKLE LUBRICATION

The closed steering knuckle requires lubrication from a source other than the gear carrier assembly. Inboard tube seals contain the hypoid gear lube in the housing to provide an adequate lubricant level for the gears, bearings, etc. This then requires an additional lubricant level to be maintained outboard, in each steering knuckle, which can be observed by removing fill plugs on each knuckle. Adequate level would be to the bottom of the fill plug hole, when vehicle is observed to be in a normal horizontal position.

Recommended lubricant is a S.A.E. 140 grade, multipurpose gear lubricant meeting the Mil-L-2105-B specification.

### COLD WEATHER OPERATION

If the vehicle is operated below  $0^{\circ}$  F ( $-18^{\circ}$  C), it is advisable to use S.A.E. 80 multipurpose gear lubricant meeting Mil. Spec. L-2105-B and suitable for A.P.I. Service Classification GL-5.

### SUBMERSION OR DEEP WATER FORDING

If the vehicle is exposed to water deep enough to cover the hubs of either the front or rear axles, it is recommended that the wheel ends be disassembled and inspected for water damage, and/or contamination daily.

Clean, examine and replace damaged parts if necessary, prior to relubricating and assembling the wheel end components. Pay particular attention to the bearings and the closed steering knuckle on the front driving axle.

In the event the gear carrier housing should become submerged in water, particularly if over the breathers, it is recommended that the hypoid gear lubricant be drained daily and internal parts be inspected for water damage and/or contamination.

Clean, examine and replace damaged parts if necessary, prior to assembling the cover housing and refilling with the specified hypoid lubricant.

### NOTE

It is recommended that whenever bearings are removed they are to be replaced with new ones, regardless of mileage.

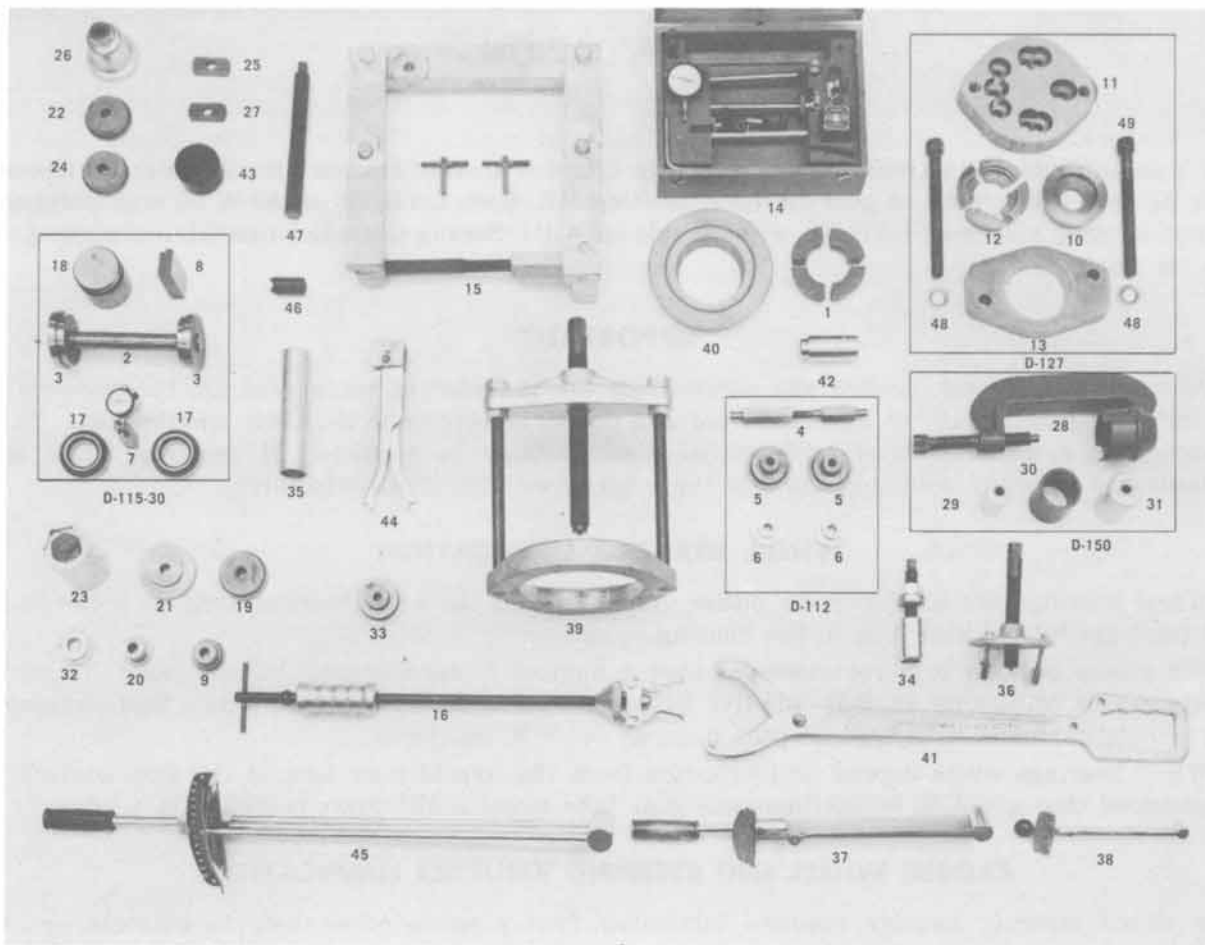


Figure 2

1008-2

The following is a detailed list of all Special Tools required to service the Model 30 Rear Axle:

Item No.	Tool No.	Description	Item No.	Tool No.	Description
1	C-293-39	Adapter Set—Differential & Rear Pinion Bearings cones	*18	D-138	Master Pinion Block
*2	D-115-3	Arbor	19	D-140	Installer—Front Brake Hub Cup
*3	D-115-4	Arbor Discs	20	D-141	Installer—Front Spindle Bushing
****4	D-112	Screw—(Use with D-112-4 & D-112-5)	21	D-143	Installer Front Brake Hub & Spindle Seal
****5	D-112-4	Installer—Front Axle. Differential Inner Oil Seal (integral)	22	D-144	Installer—Front Pinion Bearing Cup
****6	D-112-5	Installer—Front Axle. Differential Inner Oil Seal (two-piece)	23	W-144-A	Wrench—Wheel Bearing Adjusting
*7	D-115	Scooter Gauge	24	D-146	Installer—Rear Pinion Bearing Cup
*8	D-115-1	Pinion Height Block	25	D-147	Remover—Front Pinion Bearing Cup
9	D-122	Installer—Front spindle needle bearing	26	W-147-D	Installer—Pinion Oil Seal
**10	D-127-1	Installing Ring—Bearing	27	D-149	Remover—Rear Pinion Bearing Cup
**11	D-127-2	Flange Plate—Axle	***28	D-150-1	Remover & Installer—Front Axle Ball Joint
**12	D-127-3	Adapters—Removal	***29	D-150-2	Adapter—Ball Joint Removing
**13	D-127-4	Forcing Plate	***30	D-150-3	Sleeve—Ball Joint Removing
14	D-128	Indicator Set	***31	D-150-4	Sleeve—Ball Joint Installing
15	D-113	Spreader			
16	D-131	Slide Hammer Puller			
*17	D-134	Master Bearing Differential			

Item No.	Tool No.	Description
32	D-151	Installer—King Pin Bearing Cup
33	D-152	Installer—Axle Shaft Inner Oil Seal
34	W-162	Installer—Flange or Yoke
35	W-262	Installer—Rear Pinion Bearing
36	C-452	Remover—Flange or Yoke
37	C-524-A	Torque Wrench (100 ft. lb.)
38	C-685-A	Torque Wrench (300 inch lb.)
39	DD-914-9P	Press
40		Adapter Ring
41	C-3281	Holder—Flange or Yoke
42	SP-3289	Adapter Plug—Differential Hub
43	C-3716-A	Installer—Differential Side Bearings
44	C-4049	Remover—Bearing Cups

Item No.	Tool No.	Description
45	C-4053	Torque Wrench (300 ft. lb.)
46	C-4169	Wrench—Upper Ball Joint Removing, Installing & Torquing
47	C-4171	Handle—Universal
**48	SP-3020	Washers
**49	SP-5026	Bolts

\*Pinion Setting Gauge and Master Differential Bearing Kit D-115-30

\*\*Axle Shaft Bearing Removing and Installing Kit D-127

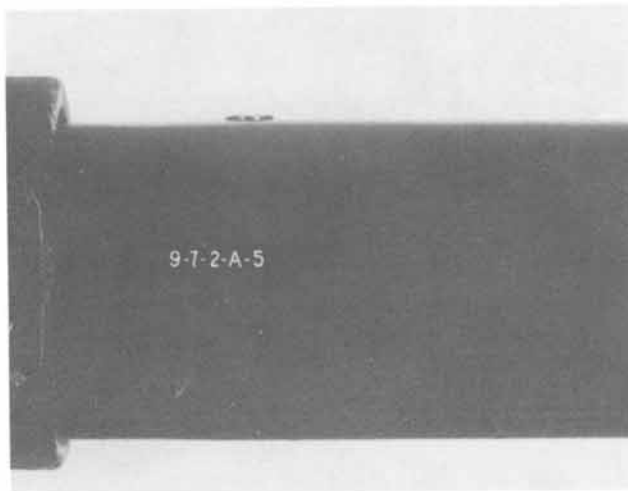
\*\*\*40 Degree Steer Front Ball Joint Removing and Installing Kit D-150

\*\*\*\*Inner Axle Shaft Seal Installer Kit D-112

**Note:** Torque wrenches C-524-A, C-685-A and C-4053 are optional and can be purchased separately. These Torque Wrenches are not included in the DW-30 Axle Tool Kit.

## AXLE IDENTIFICATION

All Dana axles are identified with a manufacturing date and the complete part number stamped on the right hand tube. Also, each axle contains a gear ratio tag, and if the axle is equipped with a limited slip differential, it will contain a tag requesting the use of limited slip lubricant.



**Figure 3**

1008-3

In this figure the axle is identified with  $\frac{1}{8}$ " high numbers stamped in the tube. For example, the numbers 9-7-2-A-5 is the manufacturing or build date of the axle and is interpreted as follows. The first number is the month, second number is the day of the month, third number is the year, the letter is the shift, and the last number is the line that built the axle. For example, September 7, 1972, first shift, line #5.

### NOTE

In the event there are two build dates, the latter will be the date in which the brake components were assembled.

It is recommended that when referring to the axle, obtain the complete part number and build date. To do this, it may be necessary to wipe or scrape off the dirt, etc., from the tube.

### NOTE

On front driving axles, the above numbers can be either on the long or short tube.



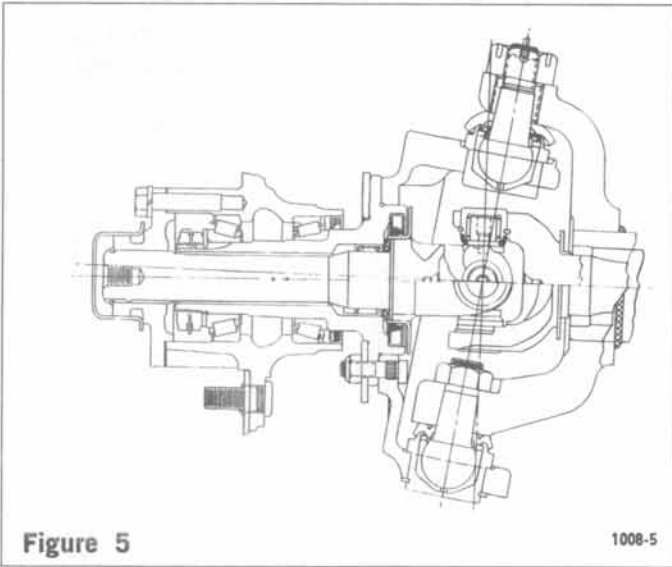
**Figure 4**

1008-4

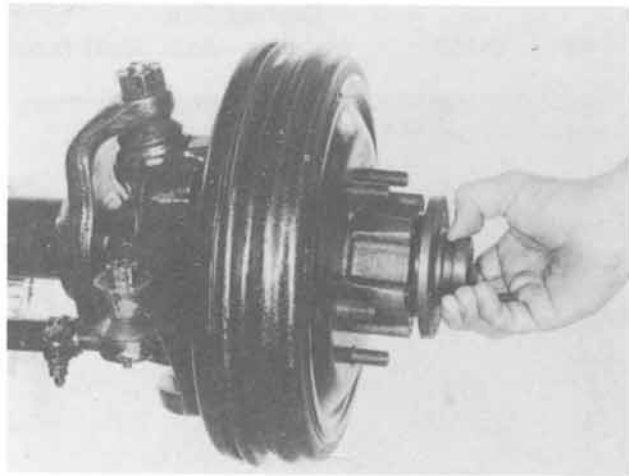
The gear ratio tag is located on the left side of the cover plate and is held in place with two cover plate screws. This tag gives the tooth combination of the ring and pinion, the total gear ratio, and also the customer part number.

If the axle is equipped with a limited slip differential, a tag calling for the usage of limited slip lubricant will be located on the bottom right side of the cover plate.

# FRONT AXLE

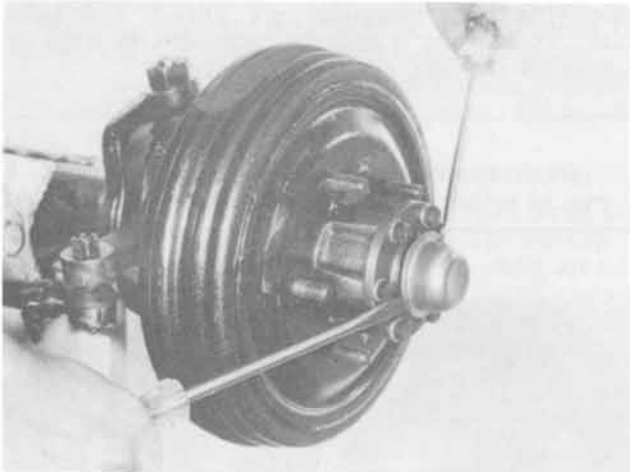


**Figure 5**  
L/D 40° Steer with External Hubs.

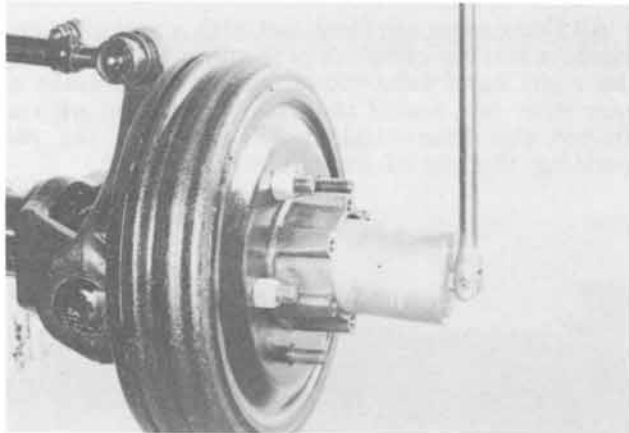


**Figure 8**  
Remove drive flange and gasket. Discard gasket. Replace gasket with a new one at time of assembly.

## DISASSEMBLY



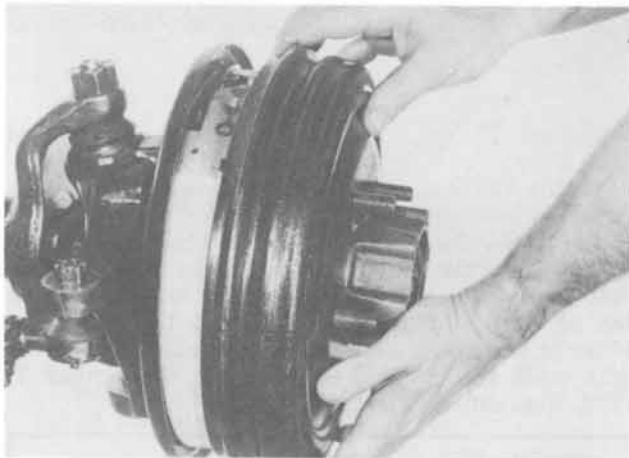
**Figure 6**  
Remove hub cap.



**Figure 9**  
Remove outer locknut, lock ring, and wheel bearing adjusting nut. Tool W-144-A Wheel Bearing Nut Wrench.



**Figure 7**  
Remove snap ring and drive flange screws.



**Figure 10**  
Remove drum assembly. Outer wheel bearing will slide out as drum is removed.



## FRONT AXLE

### NOTE

If it is necessary to replace brake components such as drum, shoes, backing plate, etc., refer to vehicle service manual.

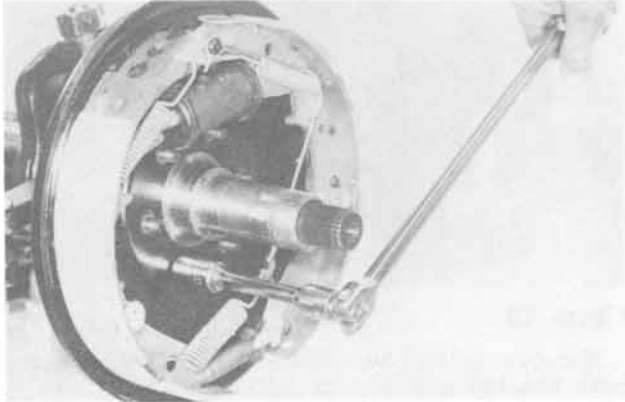


Figure 11

1008-11

Remove brake plate screws and brake backing plate.

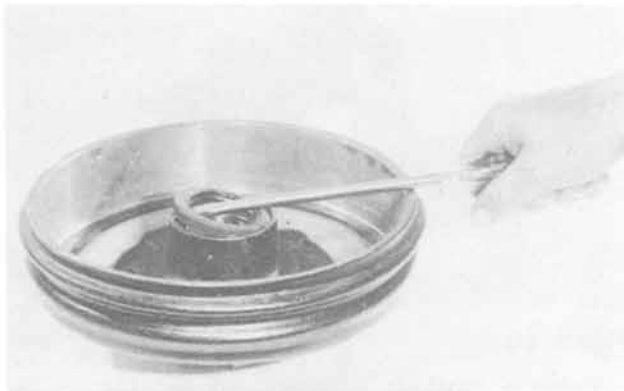


Figure 12

1008-12

Remove grease seal and inner wheel bearing cone.



Figure 13

1008-13

Remove inner wheel bearing cup. Locate tool on cup and drive out. Tool #C-4049.



Figure 14

1008-14

Remove outer wheel bearing cup. Locate tool on cup and drive out. Tool C-4049.

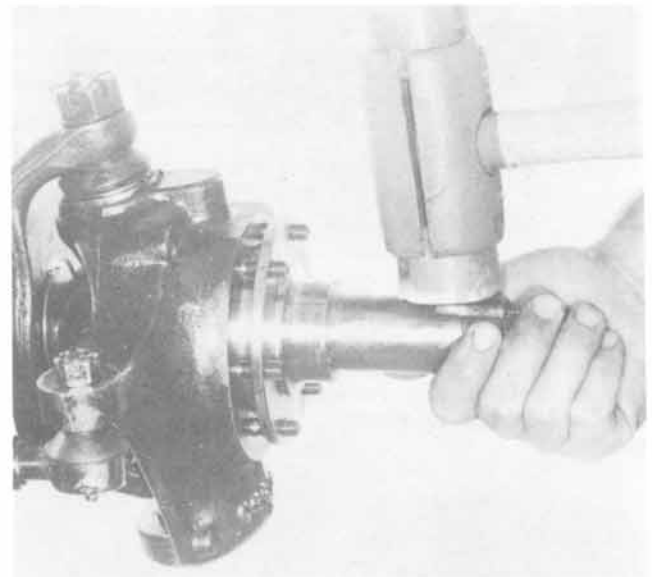


Figure 15

1008-15

Remove spindle. If necessary, tap lightly with a rawhide hammer to free it from the knuckle. Check bronze spacer located between shaft and joint assembly and bearing. If wear is evident, replace with new one.

### NOTE

Be sure that vise jaws are equipped with brass protectors or similar type to protect the machined surfaces of any parts that are to be placed in the vise.

# FRONT AXLE

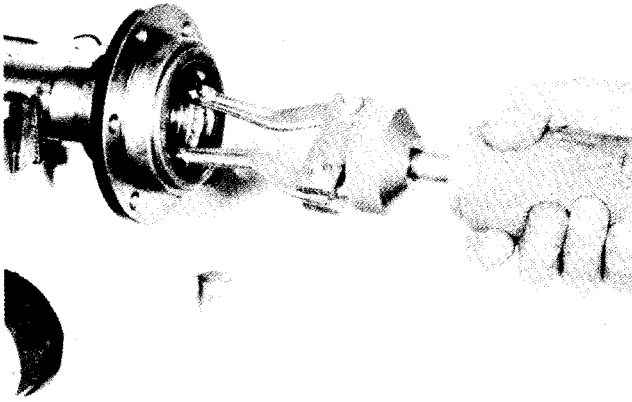


Figure 16

1008-16

Place spindle in vise. Do not locate on bearing diameters. Remove grease seal. Tool D-131 Slide Hammer.

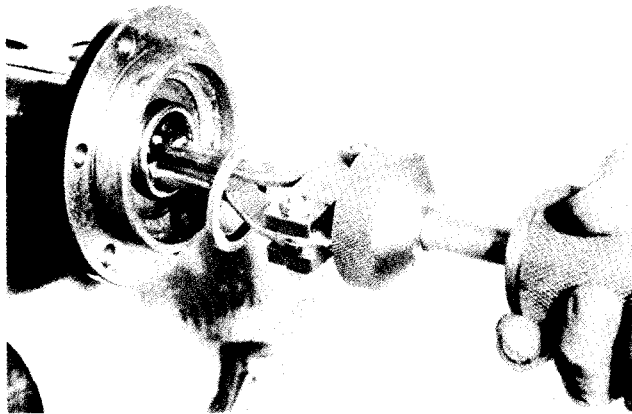


Figure 17

1008-17

Remove needle roller bearing. Bronze bushing may stick to the bearing as the spindle is removed but can be removed when removing the needle bearing as shown. Tool D-131 Slide Hammer.

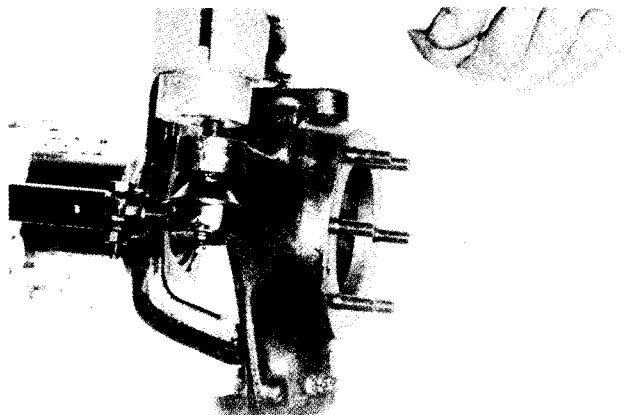


Figure 18

1008-18

Remove cotter key from tie rod nut. Loosen nut. Tap on tie rod nut to free it from the steering arm. Remove nut and disconnect tie rod.

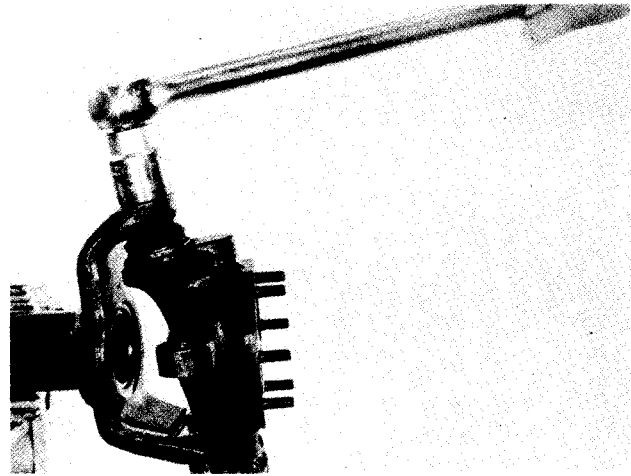


Figure 19

1008-19

Remove cotter key from top socket. Loosen both the top and bottom nuts.

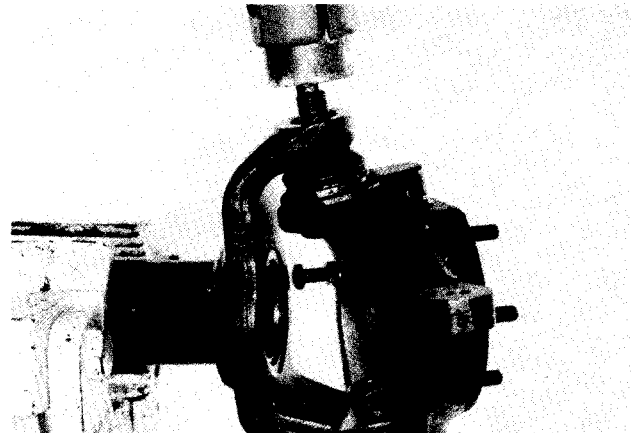


Figure 20

1008-20

Using a rawhide hammer, hit sharply on the top nut to free the knuckle from the tube yoke. After knuckle is free from the yoke, remove both the top and bottom nuts. **Discard Bottom NUT.** The nut on the bottom socket is of the torque prevailing design and is not to be reused.

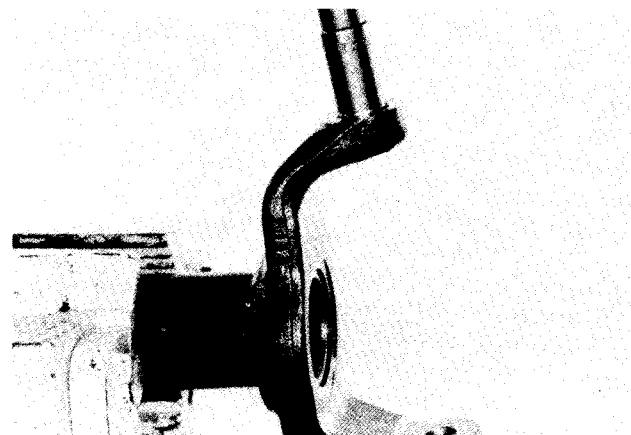


Figure 21

1008-21

Remove threaded sleeve from yoke.



## FRONT AXLE

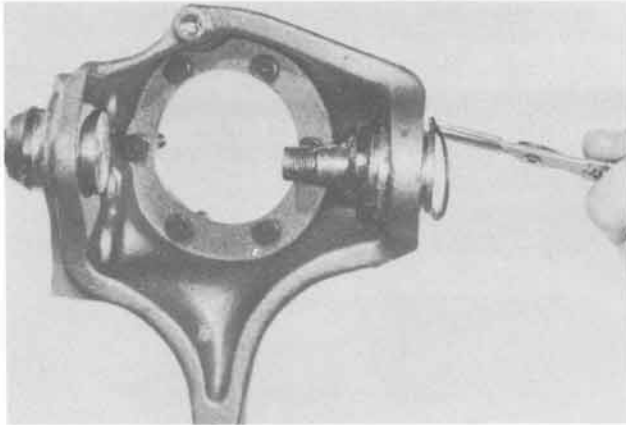


Figure 22

1008-22

Place knuckle in vise as shown. If bottom ball socket is equipped with a snap ring, remove as shown.

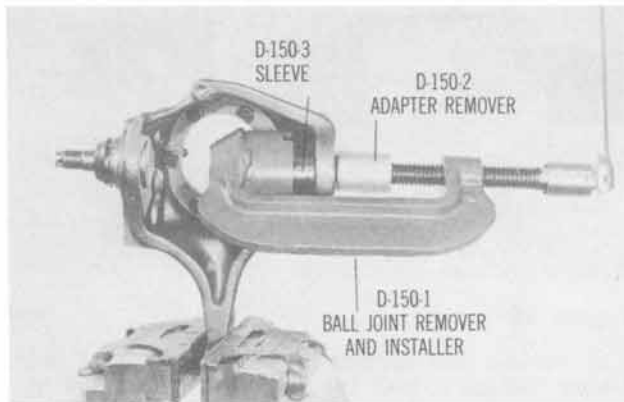


Figure 23

1008-23

### NOTE

Bottom ball socket must be removed before the top ball socket can be removed.

Assemble ball socket tools as shown. Turn forcing screw and push out bottom socket. Discard Ball Socket.

Tools—D-150-1 Ball Joint Remover & Installer, D-150-2 Adapter Remover D-150-3 Sleeve.

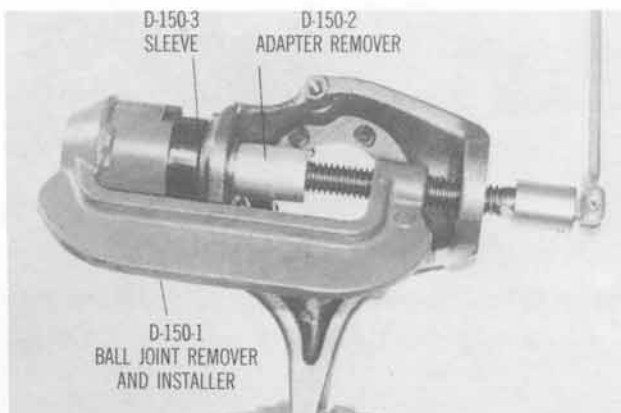


Figure 24

1008-24

Assemble ball socket tools as shown. Turn forcing screw and push out top socket. Discard Ball Socket.

Tools—D-150-1 Ball Joint Remover & Installer, D-150-2 Adapter Remover, D-150-3 Sleeve.

## ASSEMBLY

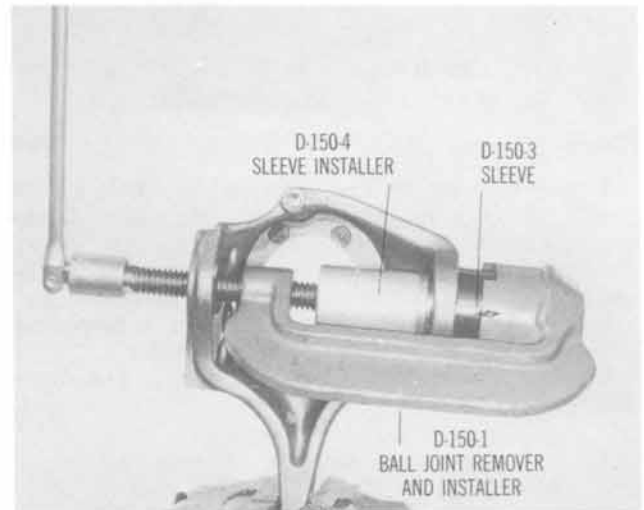


Figure 25

1008-25

(Lower ball socket does not have a cotter key hole in the stud end.)

Assemble socket into the knuckle. Make sure socket is straight.

Assemble tools as shown. Turn forcing screw and push socket into knuckle as far as it will go.

Tools—D-150-1 Ball Joint Remover & Installer, D-150-3 Sleeve, D-150-4 Sleeve Installer.



Figure 26

1008-26

If required, assembly snap ring on bottom socket.

## FRONT AXLE

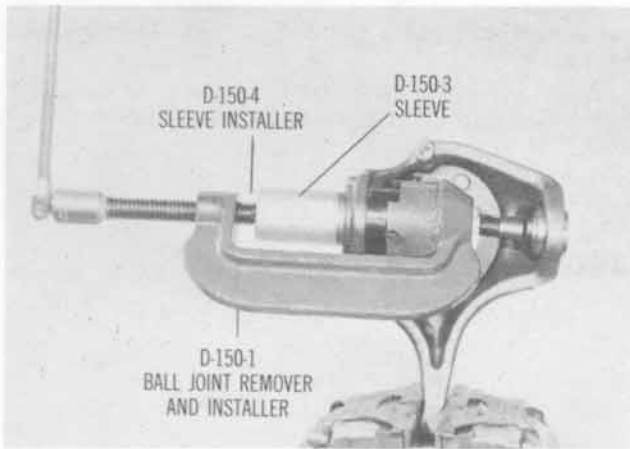


Figure 27

1008-27

Upper ball socket has a cotter key hole in the stud end. Assemble socket into knuckle. Make sure socket is straight.

Assemble tools as shown. Turn forcing screw and push socket into knuckle as far as it will go.

Tools—D-150-1 Ball Joint Installer & Remover, D-150-3 Sleeve, D-150-4 Sleeve Installer.

Remove Tools. Make sure this area is free from dirt, etc.



Figure 28

1008-28

Assemble knuckle and socket assembly to yoke as shown.

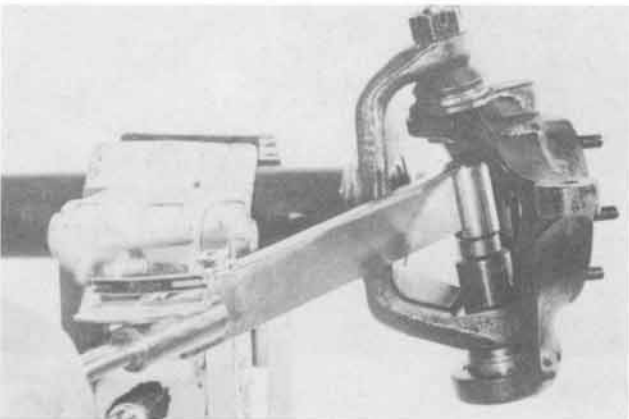


Figure 29

1008-29

Assemble new torque prevailing nut on bottom socket finger tight.

Assemble top nut on top socket. **Do not assemble sleeve at this time.**

Torque top nut until it is tight. This will pull the studs of the bottom socket into the tapered hole of the yoke.

Torque bottom nut to 80 lbs. ft.

Tool—C524-A Torque Wrench.

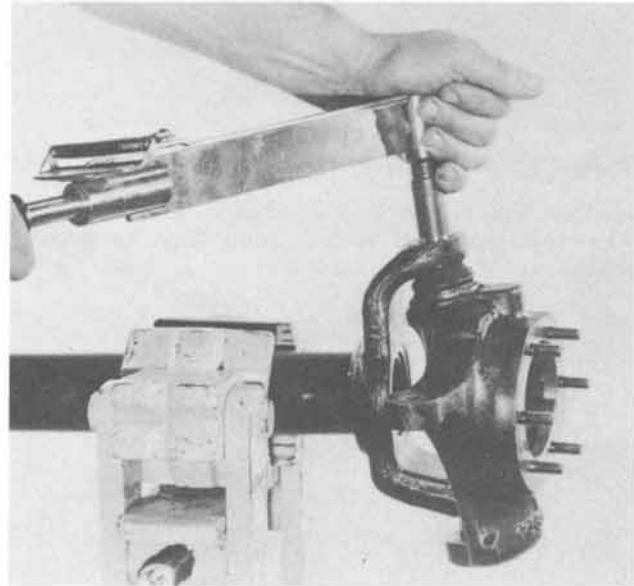


Figure 30

1008-30

Assemble new threaded sleeve into top of yoke. Using tool as shown torque sleeve to 50 lbs. ft.

Tool—C-4169 Sleeve socket, C524-A Torque Wrench.

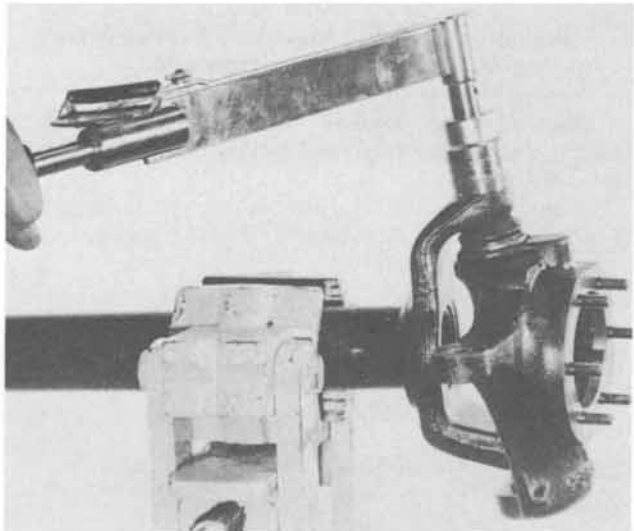


Figure 31

1008-31

Assemble top socket nut. Torque nut to 100 lbs. ft. After nut has been torqued, tighten nut to line up the cotter key hole of the stud with the next castellation or slot of the nut. **Do not loosen nut.**

Tool—C524-A, Torque Wrench.

## FRONT AXLE



Figure 32

1008-32

Assemble cotter key.

### NOTE

In the event that knuckles are received with the sockets and snap ring assembled to the knuckle, along with new top and bottom nuts, split sleeve and cotter key. Follow procedures as illustrated through Figures 28 through 32 for assembly.

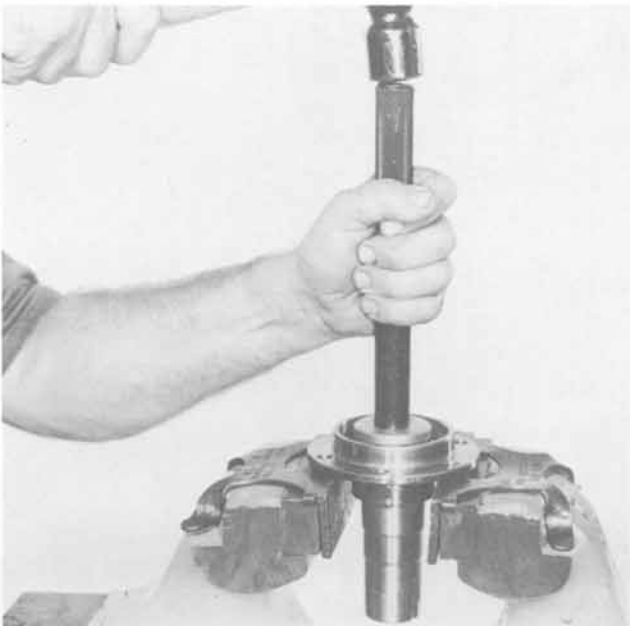


Figure 33

1008-33

Assemble new needle bearing into spindle.  
Tools—D-122 Installer, C-4171 Handle.

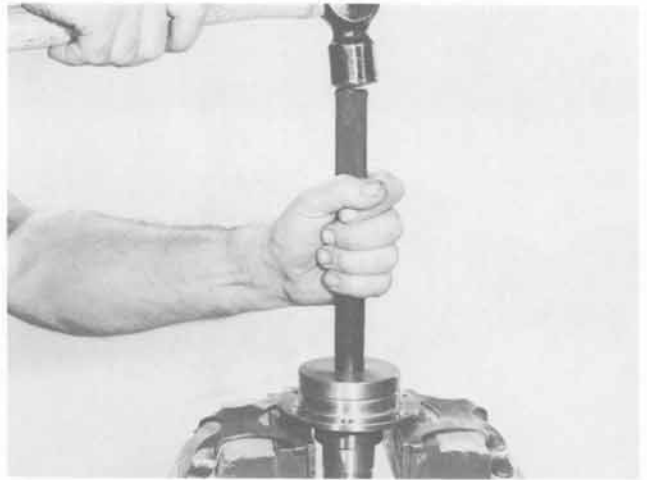


Figure 34

1008-34

Assemble new grease seal into spindle.  
Tools—D-143 Installer, C-4171 Handle.

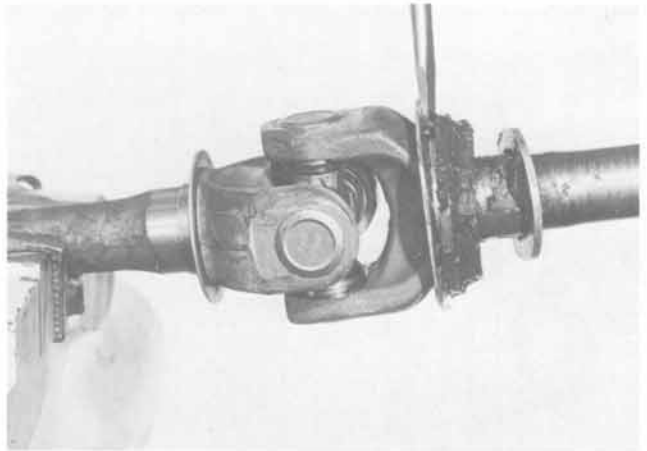


Figure 35

1008-35

Some front axles are equipped with a "V" seal which is assembled to the axle shaft stone shield as shown. If seal is worn, remove and replace with a new one.

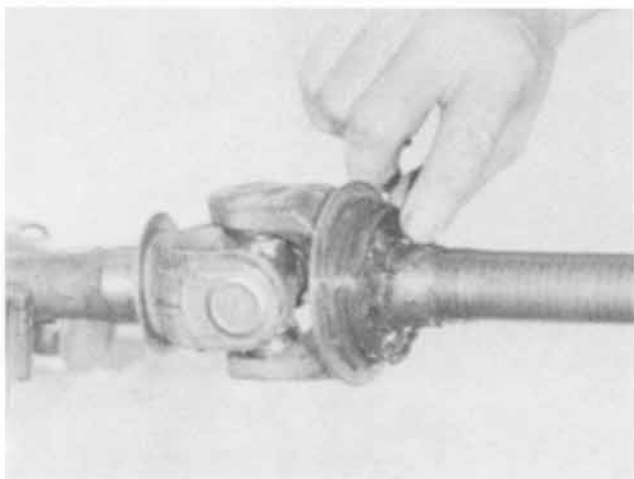


Figure 36

1008-36

Assemble new seal as shown. Lip of the seal is to be directed towards the spindle.

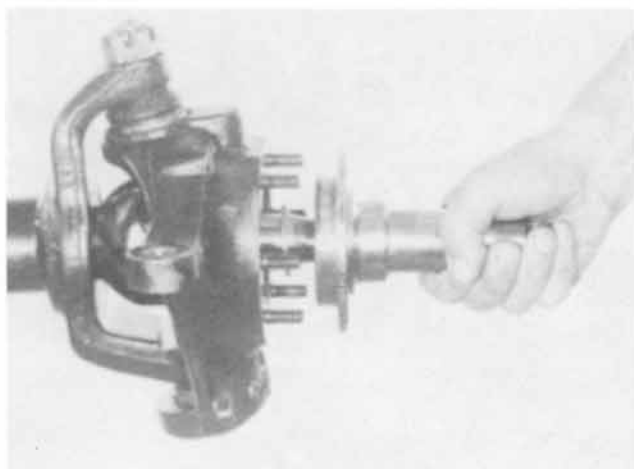
## FRONT AXLE



**Figure 37**

1008-37

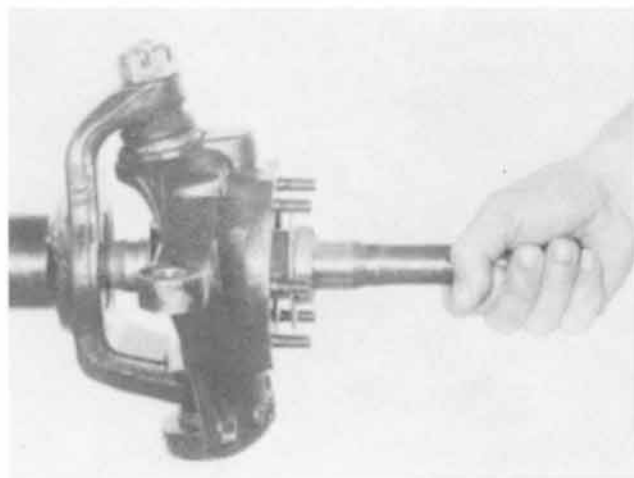
Pack the area around the thrust face area of the shaft and seal full of grease. Also, fill the seal area of the spindle with grease.



**Figure 38**

1008-38

Assemble axle shaft joint assembly into tube.



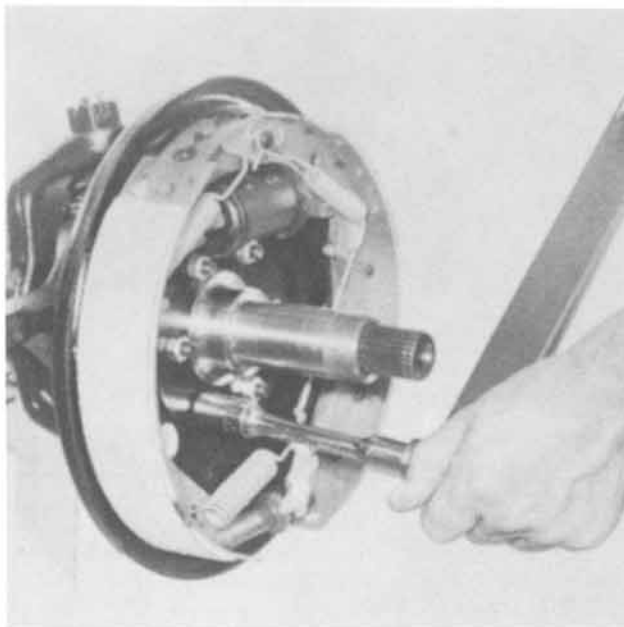
**Figure 39**

1008-39

Assemble new bronze spacer and spindle.

### NOTE

Be sure chamfer end of spacer is directed toward the seal slinger of the axle shaft joint.



**Figure 40**

1008-40

Assemble brake backing plate assembly. Assemble new nuts. Torque nuts to 25-30 lbs. ft.

Tool C524-A Torque Wrench.



**Figure 41**

1008-41

Assemble new outer wheel bearing cup.  
Tools—D-140 Installer, C-4171 Handle.

## FRONT AXLE



**Figure 42**

1008-42

Assemble new inner wheel bearing cup.  
Tools—D-140 Installer, C-4171 Handle.



**Figure 44**

1008-44

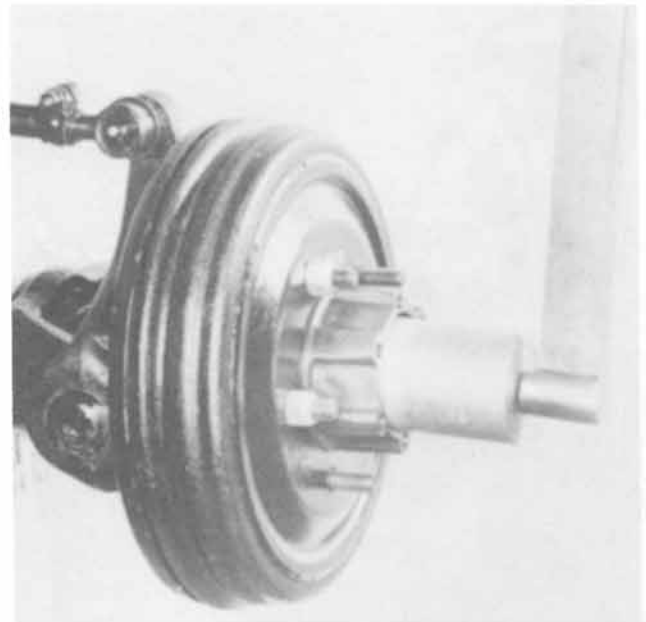
Assemble new wheel bearing grease seal.  
Tools—D-143 Installer, C-4171 Handle.



**Figure 43**

1008-43

Pack new inner bearing cone with the specified grease, assemble into hub.



**Figure 45**

1008-45

Assemble brake drum and new outer wheel bearing cone on spindle. Be sure outer wheel bearing is packed with grease. Assemble inner wheel bearing adjusting nut. Torque nut to 50 lbs. ft. Rotate hub, then back off 90° maximum. Assemble lockwashers. Assemble outer locknut. Torque nut to 50 lbs. ft. minimum.

Bend one ear inward over the flat of the wheel bearing adjusting nut. Bend one ear outward over the flat of the locknut.

Tool: W-144A Wheel Bearing Nut Wrench.

## FRONT AXLE

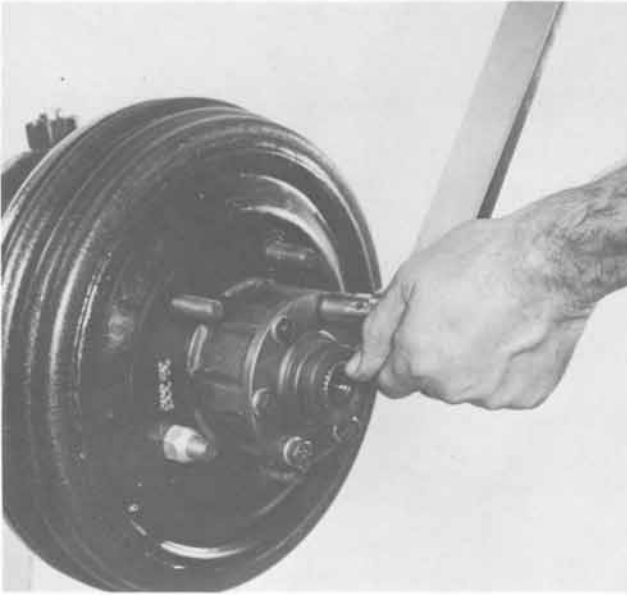


Figure 46

1008-46

Assemble drive flange, new gaskets, screws, and washers. Torque screws to 20-30 lbs. ft.

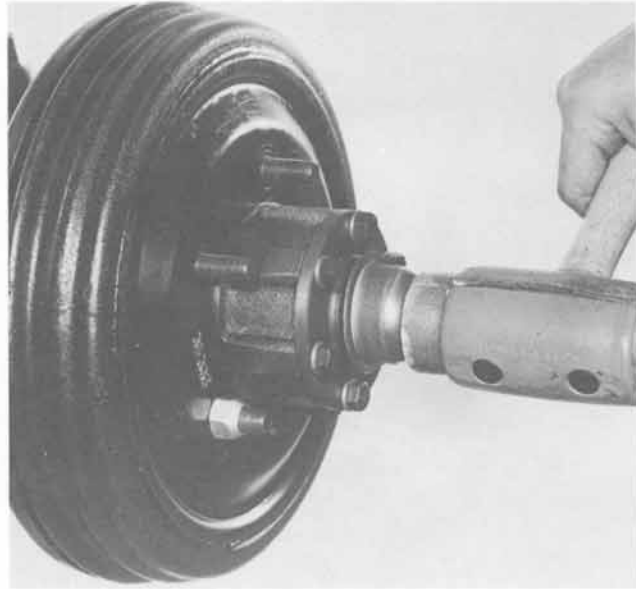


Figure 48

1008-48

Assemble hub cap.

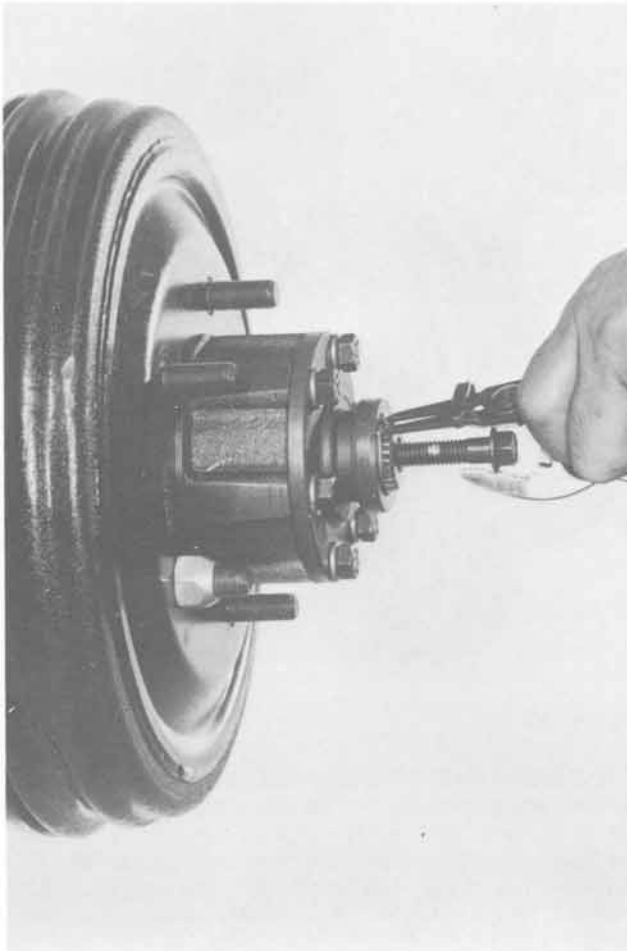


Figure 47

1008-47

Install new snap ring. Pull on bolt to acquire for snap ring groove.

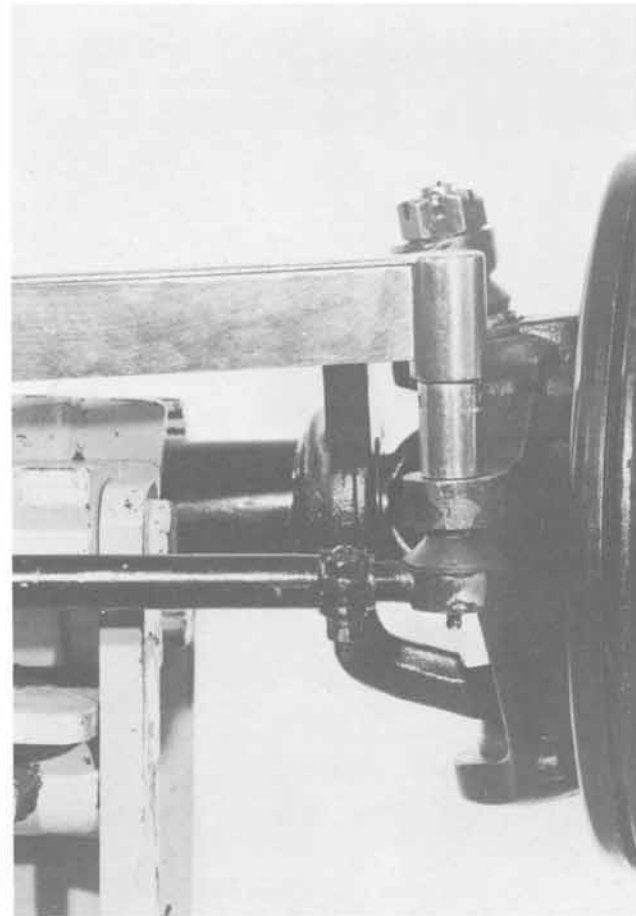


Figure 49

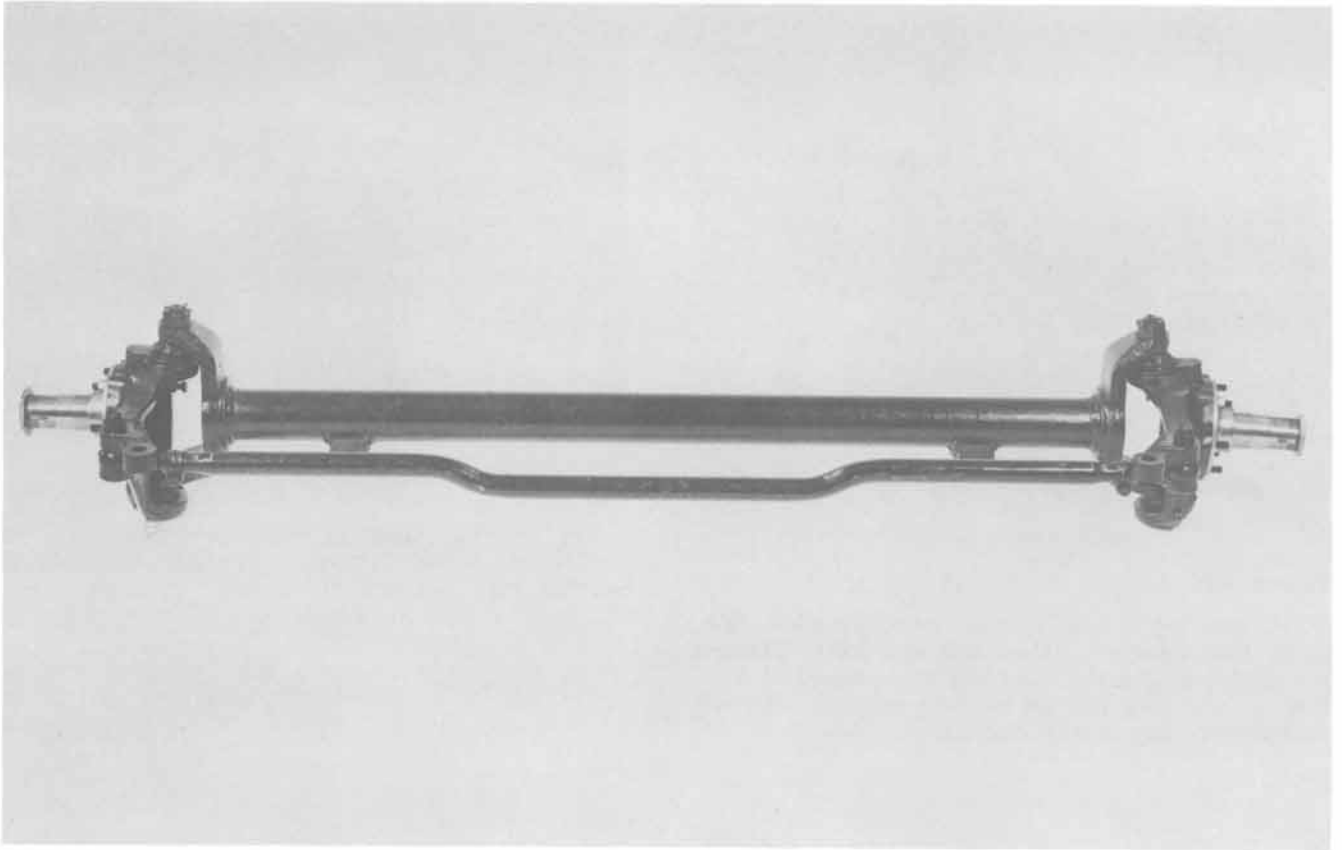
1008-49

Assemble tie rod to steering arm.

Torque nut to 25-45 lbs. ft. Line up hole of stud with slot of nut by tightening nut. (Do not loosen nut). Assemble cotter key.



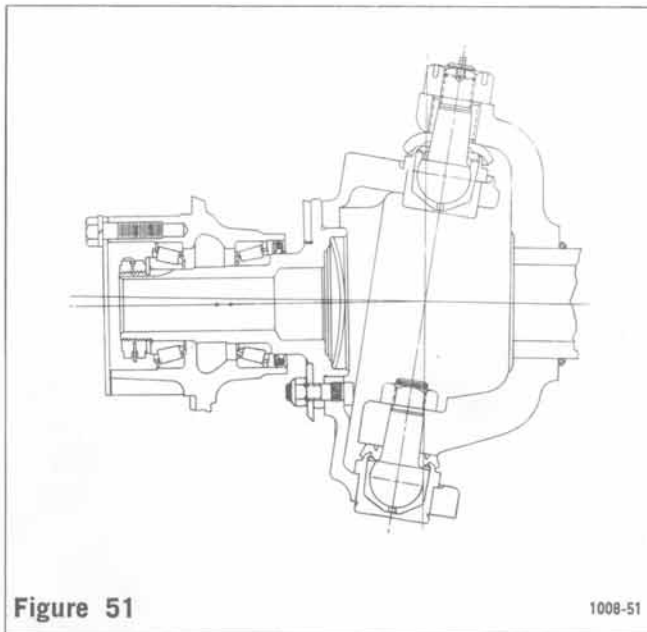
# FRONT AXLE



**Figure 50**

1008-50

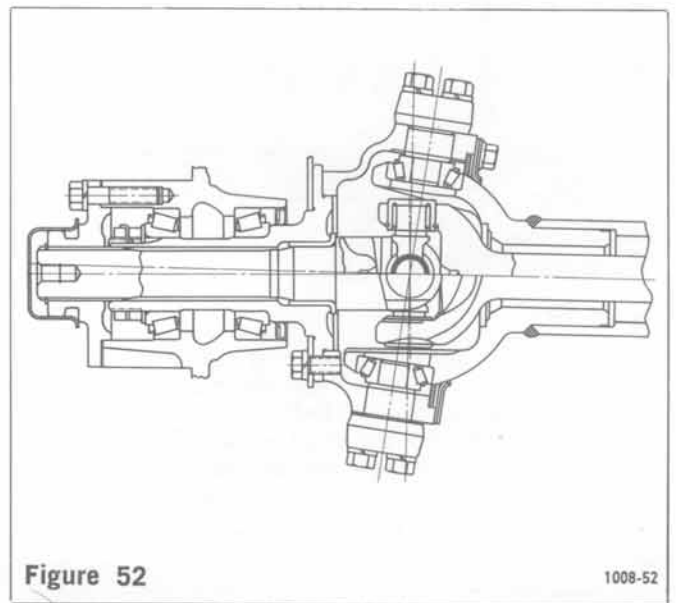
Figure 50 shows the Model 30 ball socket design non-driving front axle.



**Figure 51**

1008-51

L/D Wheel ends of this axle can be disassembled and assembled the same as illustrated in the coverage of disassembly and assembly, with the exception that there is no axle shaft joint assembly.



**Figure 52**

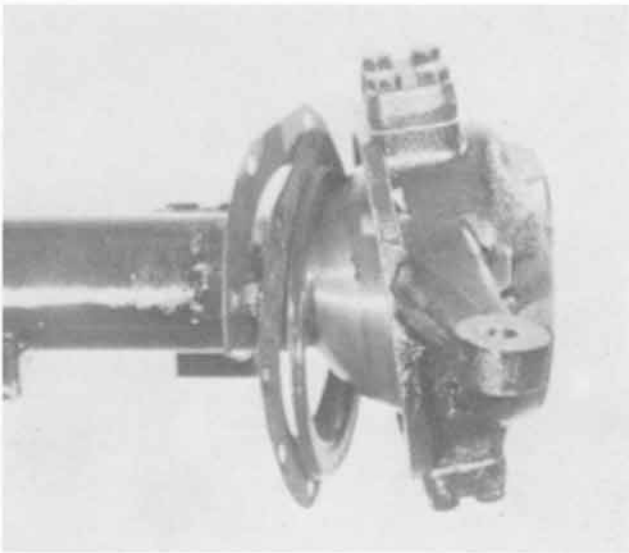
1008-52

L/D.

**Closed type knuckle standard version disassembly.**

Wheel ends such as drive flange, brakes, spindle axle shaft joint assembly can be disassembled by following the illustrations in figure 6 through 17.

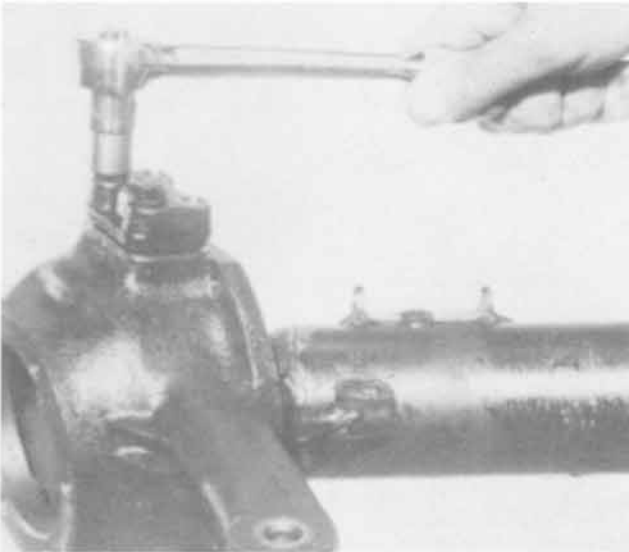
## FRONT AXLE



**Figure 53**

1008-53

Remove eight cap screws from knuckle. Remove two retainer plates, felt and seal. **Discard felt plates and seal.** They are to be replaced with new parts. Cut felt in half to remove. Spread seal for enough to slip over tube.



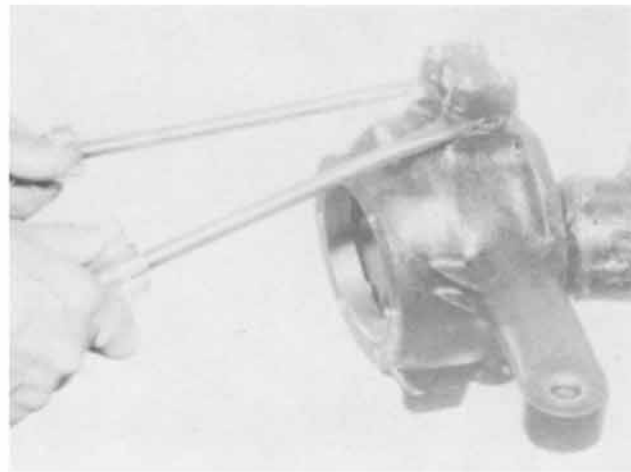
**Figure 54**

1008-54

Remove cap screws from the top and bottom bearing caps and nuts from steering arm if so equipped. Shims are located on the top bearing cap between the knuckle and the cap. These shims control the king pin bearing preload. Save these shims since they will be required at time of assembly.

### NOTE

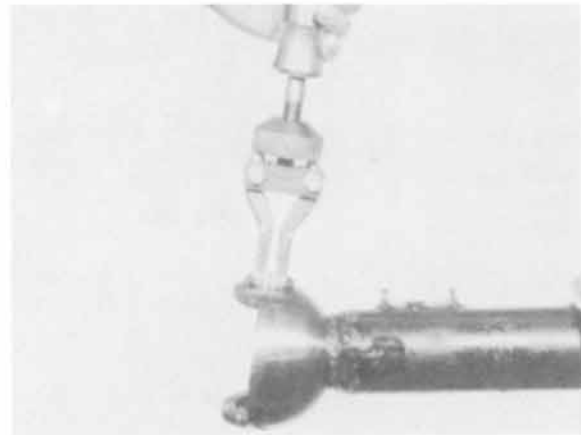
Some front axles are designed with a bronze bushing in the top king pin instead of a roller bearing. Bushing can be either the spline or key design.



**Figure 55**

1008-55

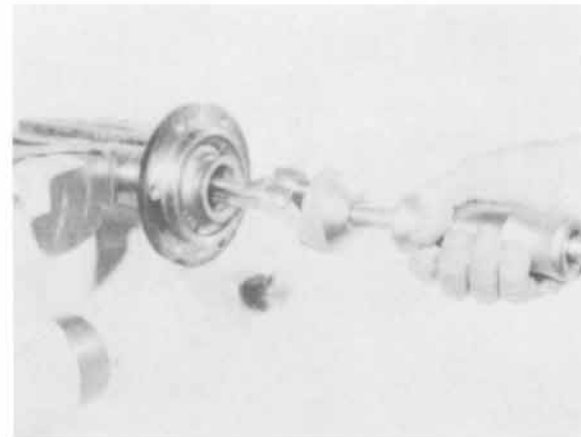
Pry bearing caps loose with screwdriver if necessary. When removing knuckle, the bottom bearing may fall out. To prevent damage, catch the bearing in your hand.



**Figure 56**

1008-56

Remove bearing cups from ball yoke, using tool as shown. Tool D-131 Slide Hammer.

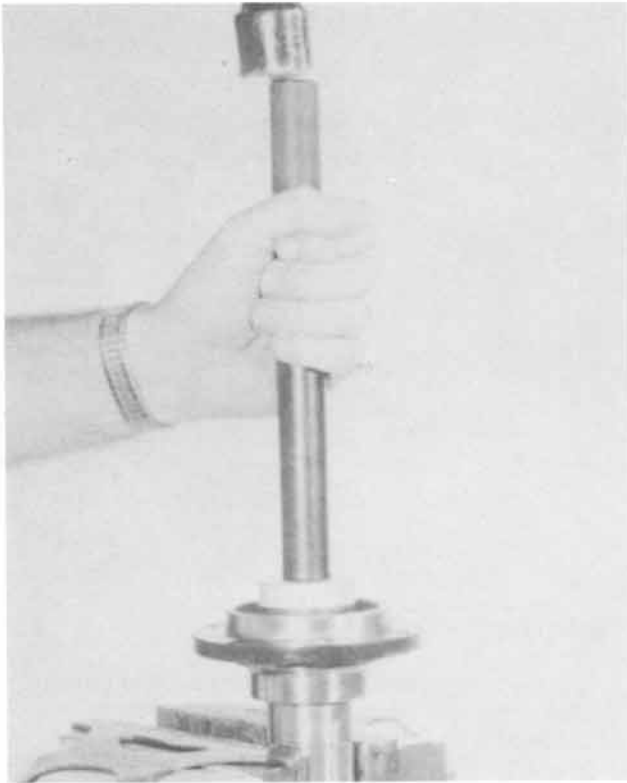


**Figure 57**

1008-57

Place spindle in vise. Do not clamp on bearing diameters. Remove bronze bushing with tools as shown. Tools D-131 Slide Hammer.

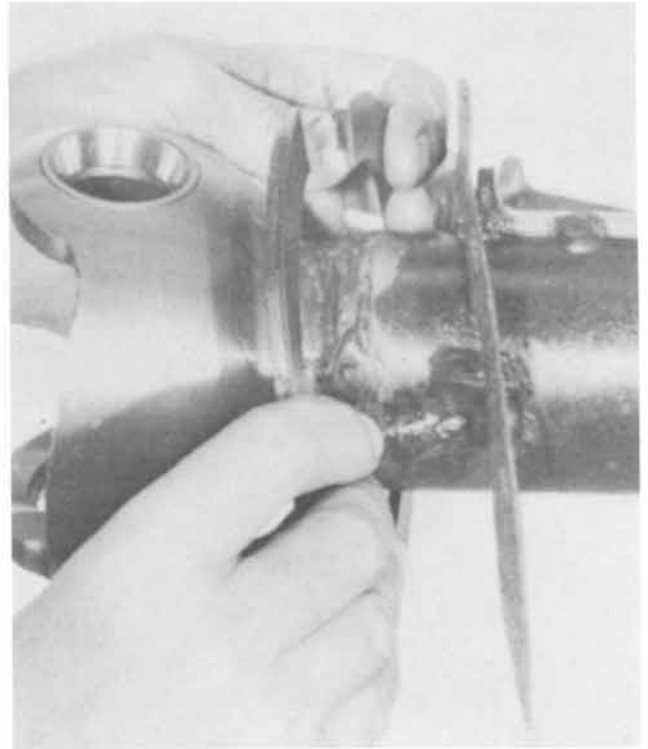
## FRONT AXLE



**Figure 58**

1008-58

Assemble new bronze bushing. Tools D-141 Installer, C-4171 Handle.



**Figure 60**

1008-60

Assemble new seal over tube. Spread seal just enough to clear tube; otherwise, it may become distorted. Metal portion of seal is to be towards the knuckle.



**Figure 59**

1008-59

Assemble new felt seal over ball yoke. Apply a thin coat of oil over ball to allow felt to slide and prevent it from tearing.



**Figure 61**

1008-61

Assemble new king pin bearing cups (top and bottom) into ball yoke. Tools D-151 Bearing Cup installer, C-47171 Handle.

# FRONT AXLE



Figure 62

1008-62

Grease top and bottom bearing cones with specified grease.

Assemble bottom bearing cap and bearing to knuckle.

Assemble top bearing into bearing cup and assemble knuckle over ball yoke.

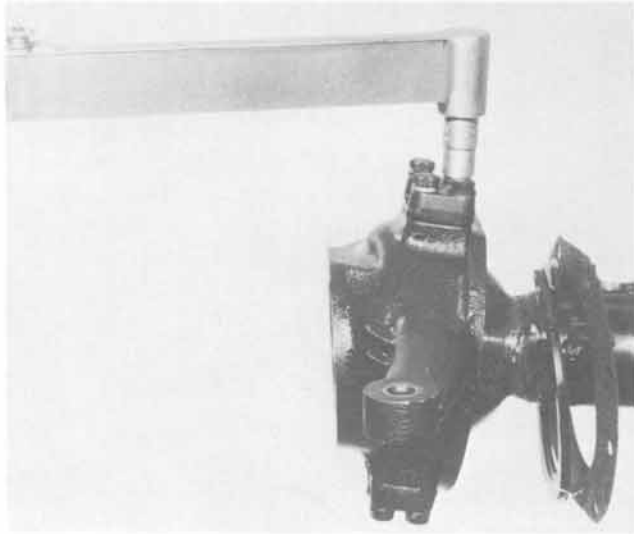


Figure 64

1008-64

Locate torque wrench on one screw to check for proper preload. Torque specifications to rotate knuckle are 5-10 lbs. ft.

If equipped with bronze bushing, torque specifications are 10-20 lbs. ft. starting torque.

To increase torque reading, remove shims; to decrease torque reading, add shims.

## NOTE

When checking king pin bearing preload, make sure the tie rod is disconnected and also the knuckle oil seals, etc., are still disassembled.

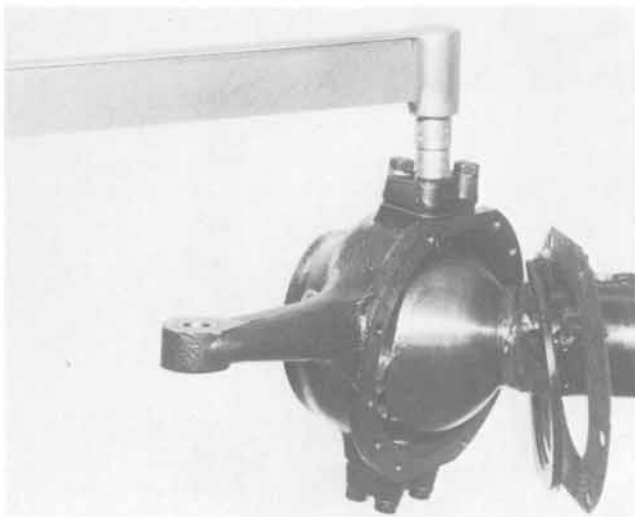


Figure 63

1008-63

Assemble preload shims and top bearing cap king pin. Assemble cap screws.

Torque screws to 30-40 lbs. ft.

Tool—C-524-A Torque Wrench.

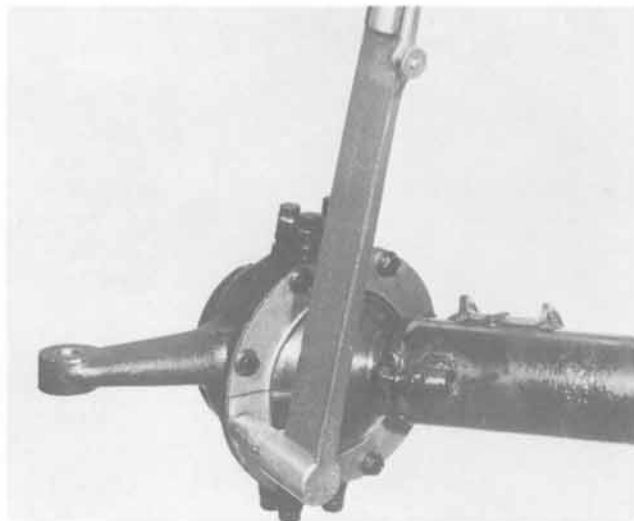


Figure 65

1008-65

Assemble new seal into knuckle, new felt seal, new retainer plates, and new screws.

Torque screws to 10-15 lbs. ft.

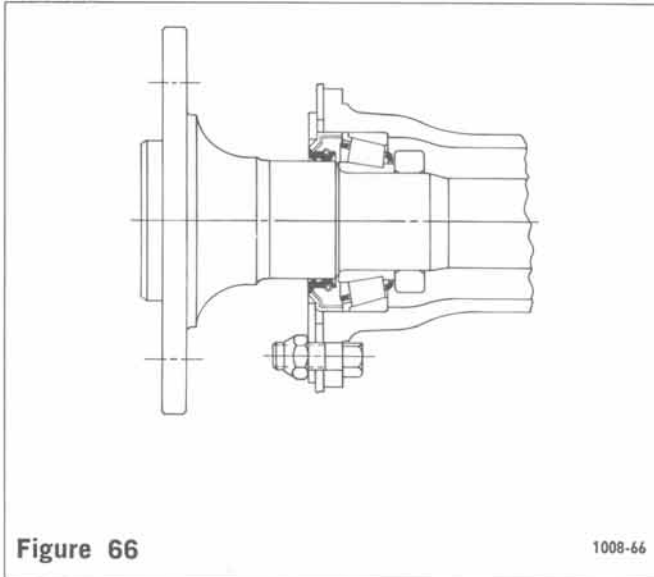
Assemble axle shaft joint assembly, spindle, wheel ends, etc.

# REAR AXLE

## UNIT WHEEL BEARING DESIGN LUBRICATED WITH HYPOID LUBRICANT

### NOTE

Unit wheel bearings that are dependent on lubrication from the hypoid gear lube in the axle housing, rather than grease, are not equipped with an inner axle shaft oil seal as shown in Figure 77.



Unit wheel bearing L/D.

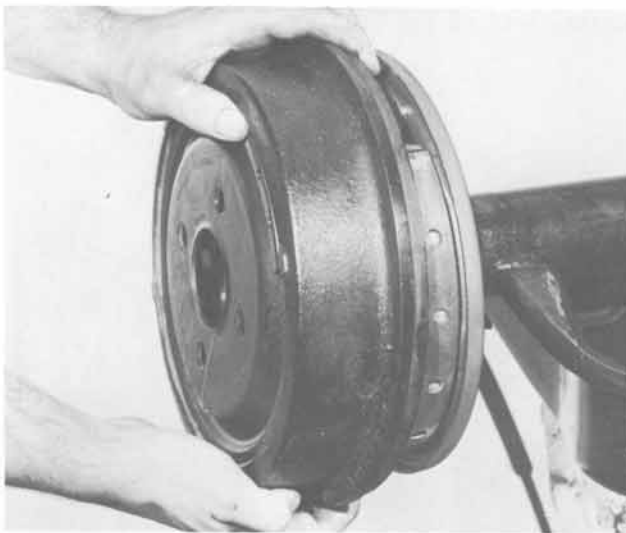


Figure 67

### DISASSEMBLY

After wheel is removed, remove brake drum.

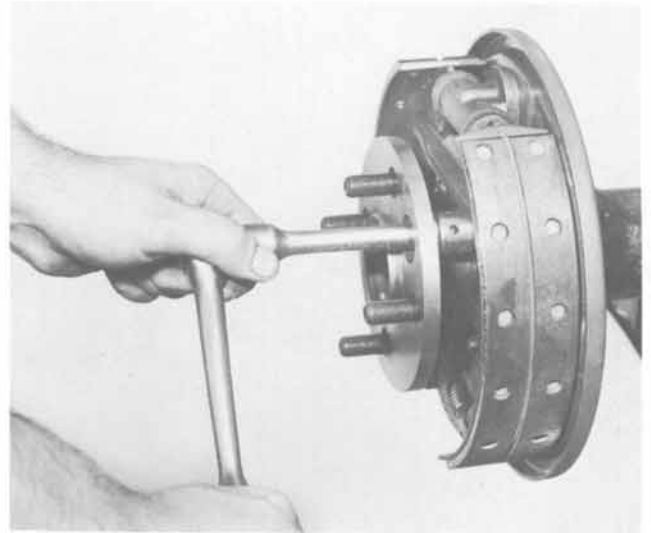


Figure 68

Remove backing plate nuts which hold the brake backing plate to the axle housing. **Discard nuts, replace with new ones at time of assembly.** Nuts are of torque prevailing design and are not to be reused.

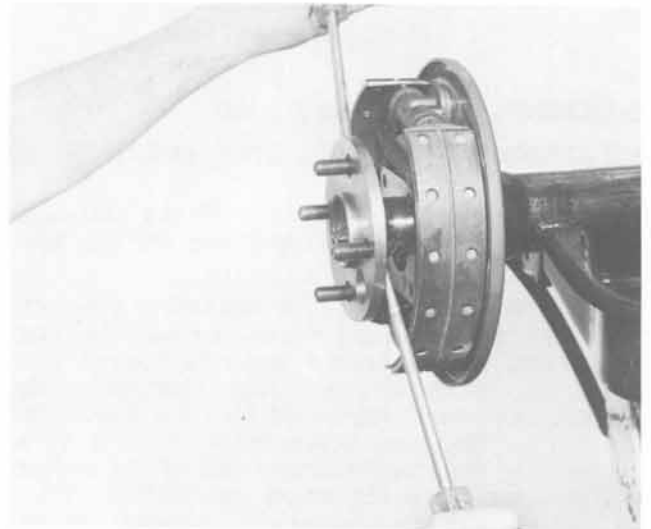


Figure 69

Remove the axle shaft by pulling on the axle. It may be necessary to free the axle shaft by prying it loose with two screwdrivers or pry bars as shown.

### NOTE

Backing plate can normally be wired to the frame, without loosening the hydraulic brake line connection at the wheel cylinder, if desired. Use caution to avoid damage to brake line.

# REAR AXLE

## ASSEMBLY

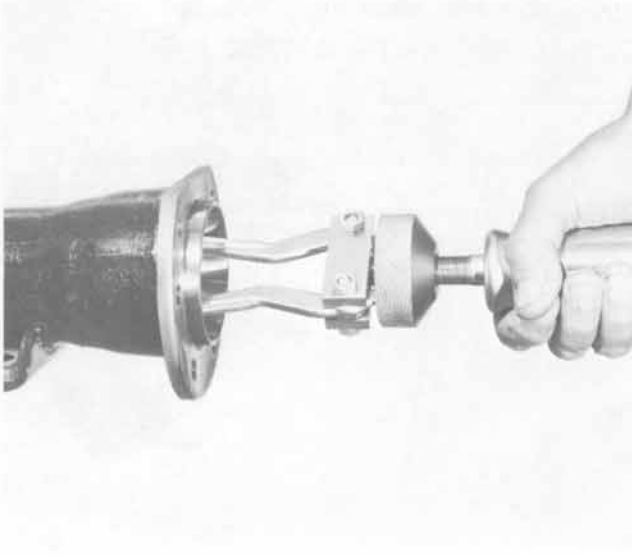


Figure 70

1008-70

The bearing cup will normally stay in place in the housing. To remove bearing cup, use puller as shown.

Tool—Slide Hammer #D-131.

## CLEANING, INSPECTING AND RELUBRICATING WHEEL UNIT BEARING

Clean bearing cup with any of the standard metal cleaning solvents. Inspect cup for any possible wear, nicks, etc.

The cone assembly can be cleaned in place on the axle shaft. Use any standard metal cleaning solvent and a stiff bristle brush to remove any dirt or any other contamination that might be present, then use compressed air. Air should be directed at the cone assembly so that it goes through the bearing from one end of the rollers to the other. It is important not to "spin dry" the bearing with compressed air. Spinning the dry bearing may score the raceways and rollers due to lack of lubricant.

Use a standard metal cleaning solvent to clean out the bearing bore in the housing. Wipe this area clean making sure it is free from dirt or any other contamination that might be present.

After the bearing has been inspected and approved for continued service, it must be lubricated prior to installation. The bearing must be lubricated by applying a small amount of specified lube around the rollers of the bearing cone.

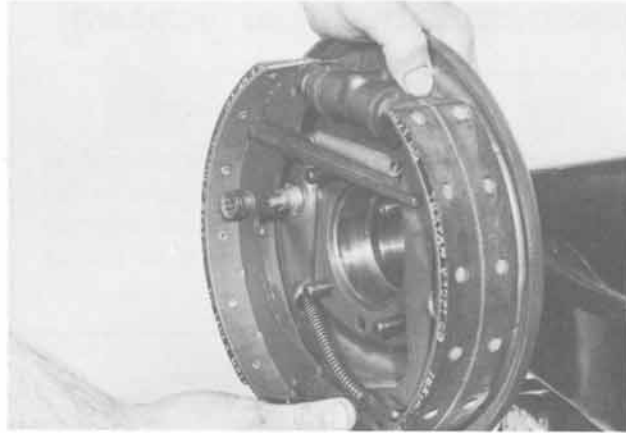


Figure 71

1008-71

Assemble backing plate bolts and backing plate assembly.

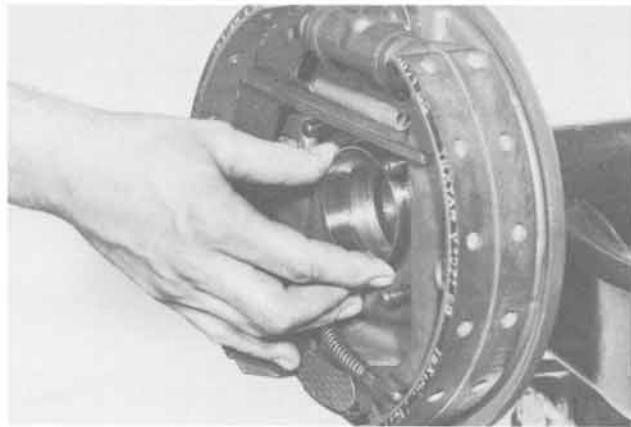


Figure 72

1008-72

Assemble bearing cup into bearing bore of the tube. Make sure the cup backface is against the bearing seat of the tube.



Figure 73

1008-73

Assemble axle shaft into housing. Care should be taken not to damage the bearing rollers.

Line up the holes of the retainer plate with the bolts, push axle shaft into the housing as far as possible.



# REAR AXLE

## UNIT WHEEL BEARING DESIGN LUBRICATED WITH GREASE

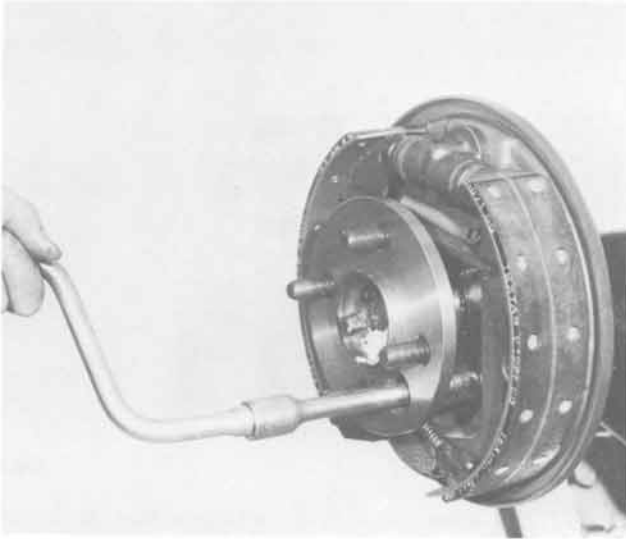


Figure 74

1008-74

Start nuts on backing plate bolts by hand. Use a speed wrench as shown and tighten to approximately 15 lbs. ft.

The nuts should be tightened in a manner that assures that the seal and cup ring are drawn evenly against the cup in the housing.

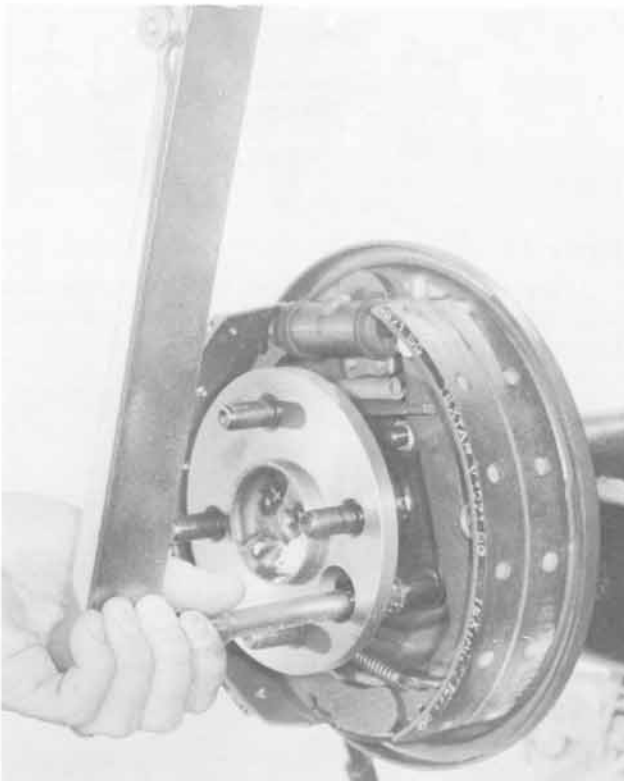


Figure 75

1008-75

Using a torque wrench as shown, torque nuts to 25-35 lbs. ft. Assemble brake drums, retainer nuts, wheels, etc.

Tool—C524-A Torque Wrench.

### NOTE

Unit wheel bearings that are dependent on grease for lubrication, rather than hypoid gear lube from the axle housing, are equipped with an inner axle shaft oil seal as shown in Figure 77.

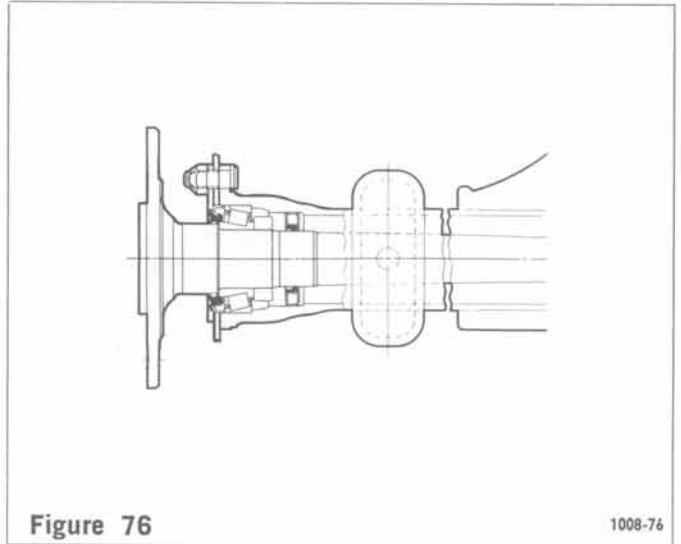


Figure 76

1008-76

Unit Wheel Bearing L/D, Showing Grease Seal.

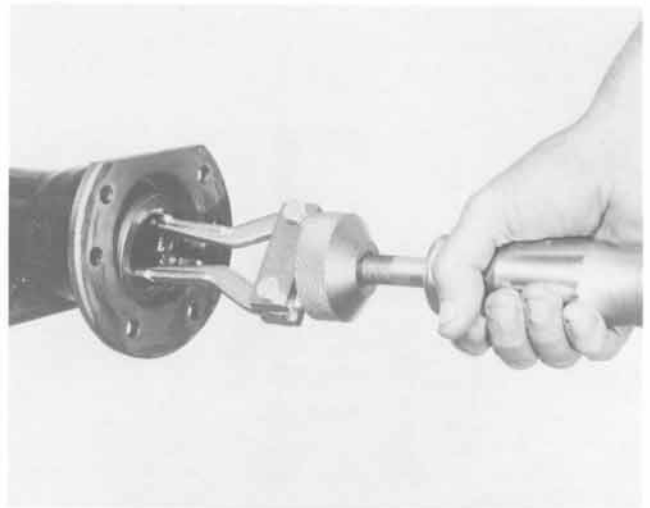


Figure 77

1008-77

Remove inner axle shaft seal using puller as shown.

Tool—D-131 Slide Hammer.

Discard Seal and replace with new one at time of assembly.

### NOTE

Avoid contacting seals with cleaning solvent in cleaning operation.

## REAR AXLE

### CLEANING, INSPECTING AND RELUBRICATING UNIT BEARINGS

Clean bearing cup with any of the standard metal cleaning solvents. Inspect cup for any possible wear, nicks, etc.

The cone assembly can be cleaned in place on the shaft. Use a standard metal cleaning solvent and a stiff bristle brush to loosen the old grease. To insure removal of the old grease and any contamination that might be present use compressed air. Air should be directed at the cone assembly so that it goes through the bearing from one end of the rollers to the other. It is important not to "spin dry" the bearing with compressed air. Spinning the dry bearing may score the raceways and rollers due to the lack of lubricant.

Use a standard metal cleaning solvent to clean out the bearing and oil seal bore in the housing. Wipe this area clean making sure it is free from any old grease or other contamination that might be present.

After the bearing has been inspected and approved for continued service, it must be lubricated prior to installation.

The grease should be a good quality number 2 E. P. (extreme pressure), lithium soap, wheel bearing grease.

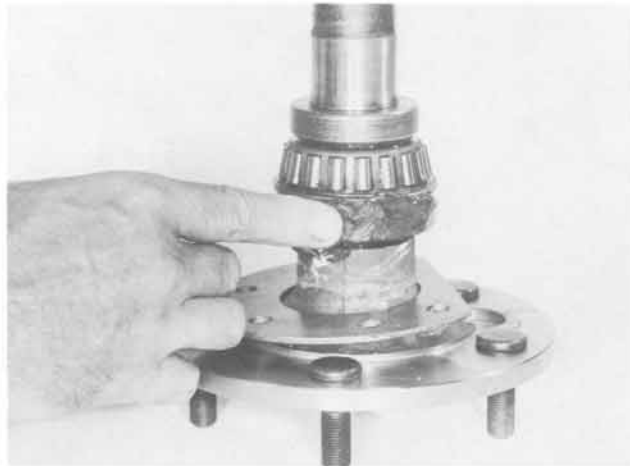


Figure 79

1008-79

Fill the area or cavity between the seal and bearing with the recommended grease.

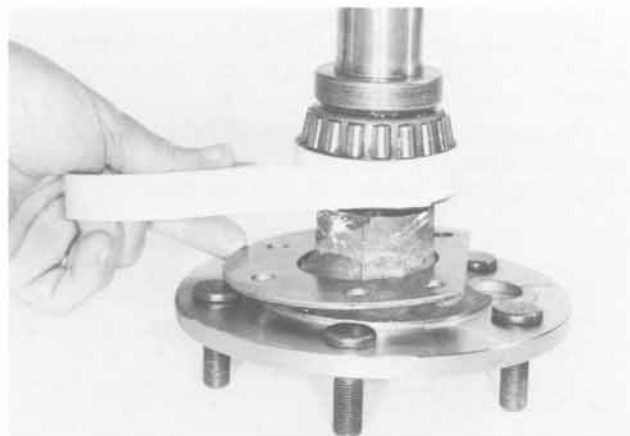


Figure 80

1008-80

After the cavity is full of grease, wrap tape completely around the rib ring and seal as shown to enclose the cavity.



Figure 81

1008-81

With tape still wrapped around the ring, push seal up until it contacts the rib ring. This will force the grease up through the rollers.

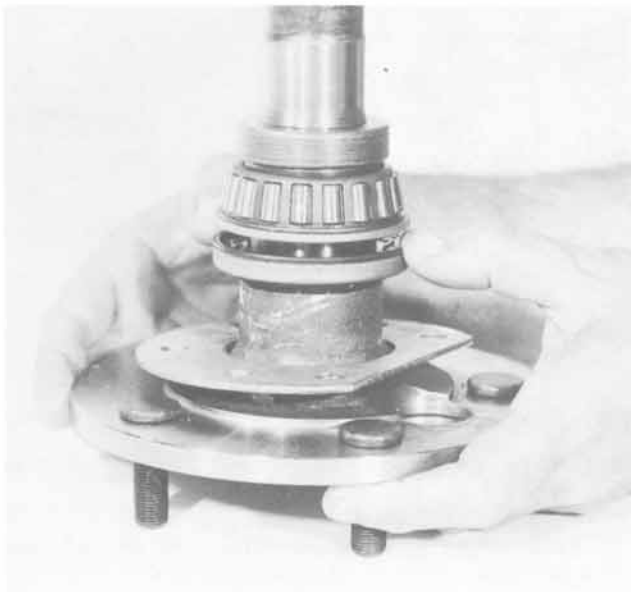


Figure 78

1008-78

Push seal and retainer away from the bearing to allow a cavity between the seal and bearing.

## REAR AXLE

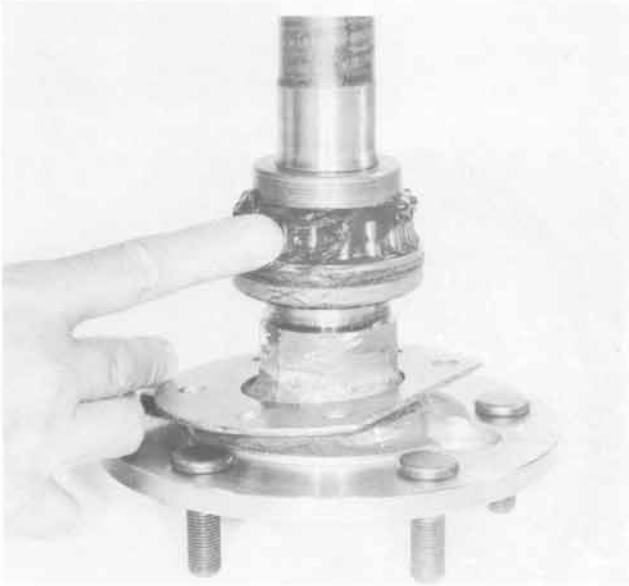


Figure 82

1008-82

### NOTE

If grease is not apparent on small end of rollers repeat these same steps until grease appears.

Remove tape and wipe excess grease on roller bodies.

## ASSEMBLY

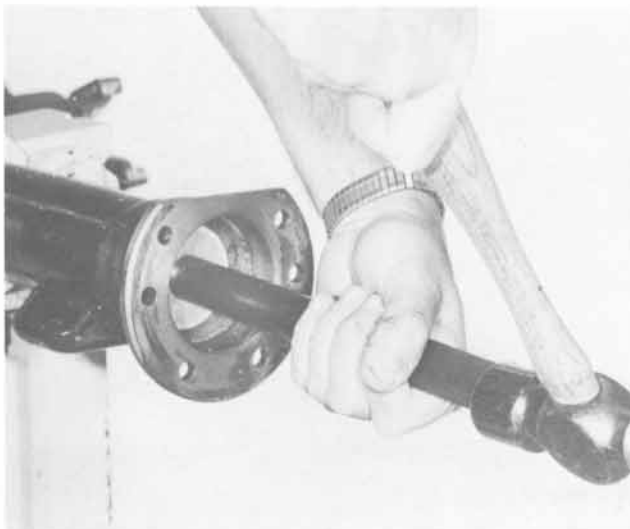


Figure 83

1008-83

Assemble new grease seal into housing.  
Tools—D-152 Seal Installer, C-4171 Handle.

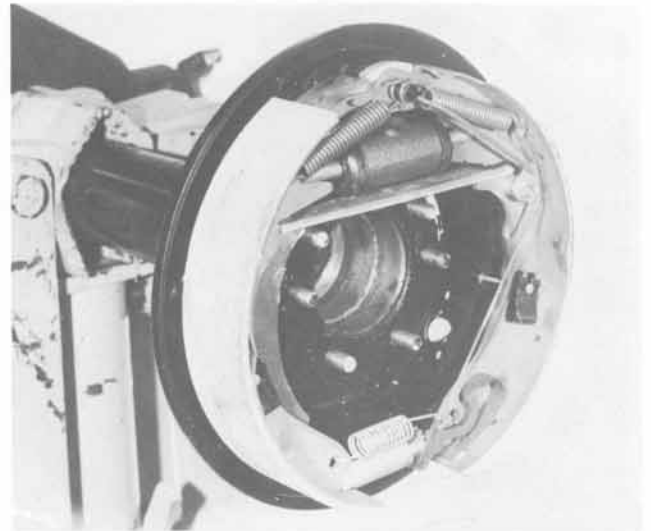


Figure 84

1008-84

After seal has been assembled, grease lip of seal.

Assemble backing plate bolts and backing plate assembly.

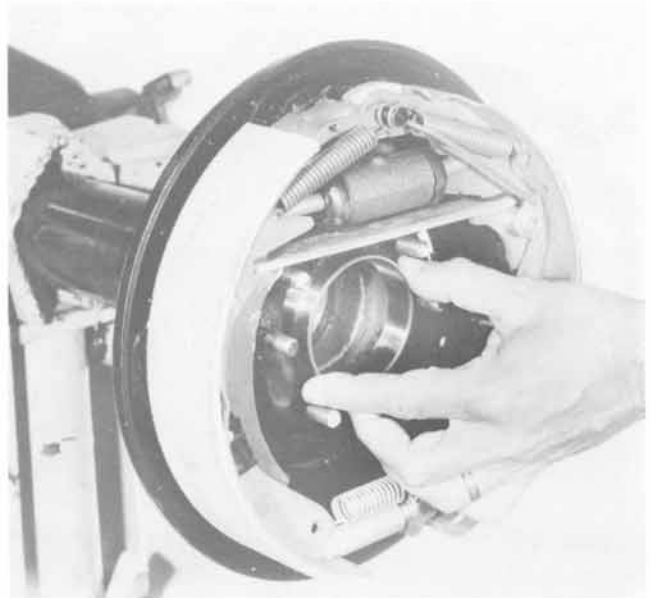


Figure 85

1008-85

Assemble bearing cup into bearing bore of the tube. Make sure the cup backface is against the bearing seat of the tube.

## REAR AXLE



Figure 86

1008-86

Assemble axle shaft into housing. Care should be taken not to damage the seal lip and bearing rollers.

Line up the holes of the retainer plate with the bolts, push axle shaft into the housing as far as possible.

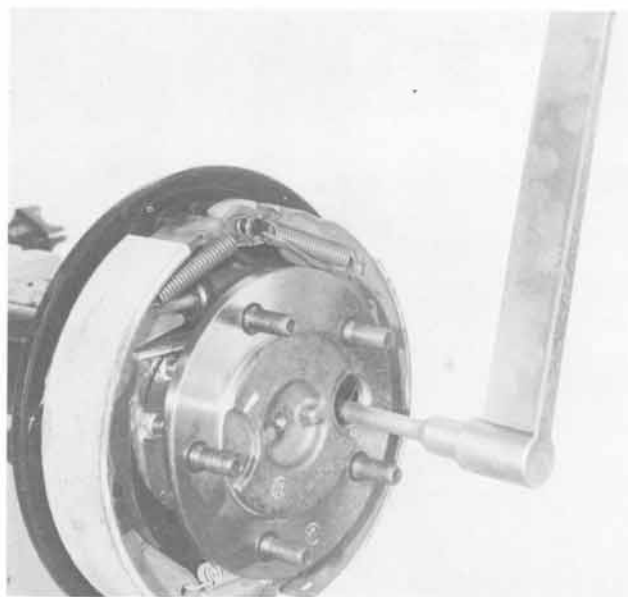


Figure 88

1008-88

Use a torque wrench and torque nuts to 25-35 lbs. ft.

### REMOVAL OF UNIT BEARING FROM AXLE SHAFT

#### NOTE

To disassemble axle shaft from housing, follow the procedures illustrated in Figures 67 through 70.

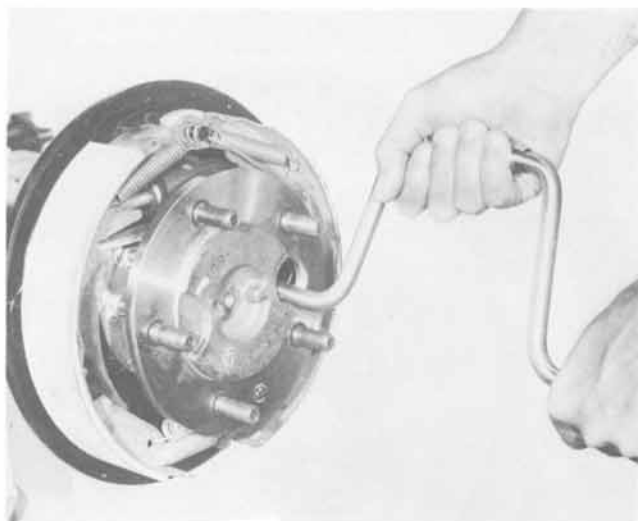


Figure 87

1008-87

Start nuts on backing plate by hand. Use a speed wrench as illustrated and tighten to approximately 15 lbs. ft.

The nuts should be tightened in a manner that assures the seal and cup rib ring are drawn evenly against the cup in the housing.



Figure 89

1008-89

Place axle shaft in a vise. Drill a  $\frac{1}{4}$ " hole in the outside of the retainer ring to a depth approximately  $\frac{3}{4}$  the thickness of the ring. Do not drill all the way through the ring; the drill could damage the axle shaft.

## REAR AXLE



Figure 90

1008-90

After drilling the ring, use a chisel positioned across the hole and strike sharply to break the ring. Discard and replace with a new one at time of assembly.

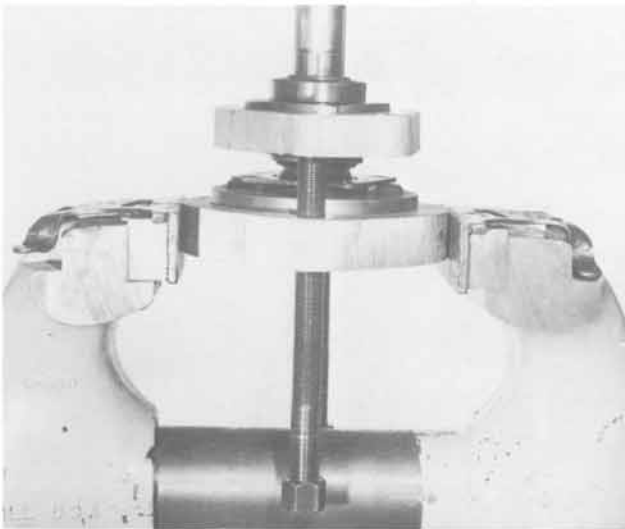


Figure 91

1008-91

Push retainer plate and seal towards flange of axle shaft. Install the flange plate to the flange of the axle shaft. Install bolts into flange plate. Slide forcing plate over the axle shaft. Install the adapters so they seat under the cup rib ring.

Gradually tighten the bolts until they locate in the dimples on the back side of the forcing plate.

Tools—Flange plate #D-127-2, Forcing Plate #D-127-4, Adapters #D-127-3, Bolts #SP-5026.

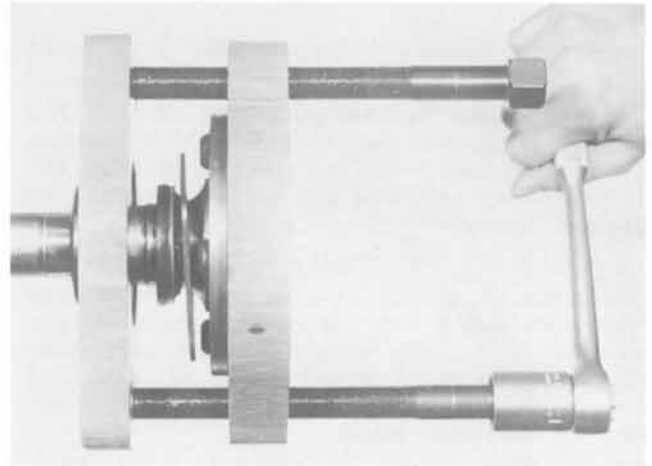


Figure 92

1008-92

Tighten bolts of tool alternately until bearing cone is removed from axle shaft. Be careful not to mar the machined surfaces of the axle shaft.

### CAUTION

Do not heat or cut the bearing cone assembly with a torch to remove. Damage to the axle shaft will result.

Remove seal and retainer plate. Discard seal. Replace with new one at time of assembly. Inspect retainer plate for possible distortion. If any portion of the retainer plate is damaged, it should be replaced.

Inspect machined surfaces of the axle shaft, such as the seal and bearing diameters. Clean axle shaft, remove all nicks or burrs.

### INSTALLATION OF NEW UNIT BEARING

#### NOTE

The retainer ring area of the axle shaft is 1.3790 minimum in diameter, and the retainer ring inside diameter is 1.374 maximum. Therefore, it should require some 6,000 lbs. minimum press to seat the ring against the unit bearing.

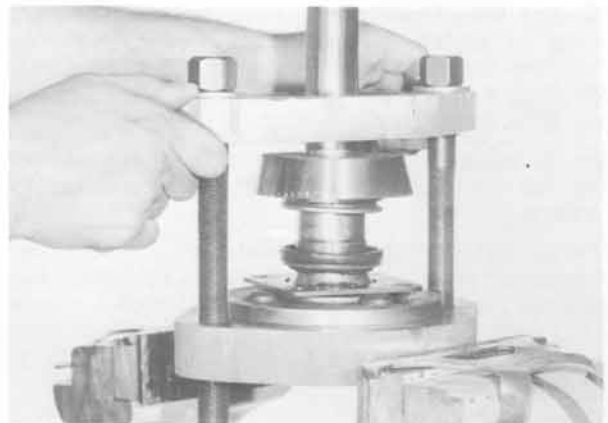


Figure 93

1008-93

Flange plate should still be assembled to the

## REAR AXLE

flange of the axle shaft. Remove bolts from flange plate.

Assemble new retainer plate and oil seal. The rubber portion of the oil seal, which extends beyond the casing has numbers bonded in the rubber. These numbers are to face toward the flange of the axle shaft.

Assemble new unit wheel bearing on axle shaft.

Slide installing ring on axle shaft. Be sure to locate unit wheel bearing on the inside of the installing ring. Slide forcing plate on axle shaft and locate on installing ring. Install bolts and washers through the holes in the forcing plate and into the flange plate.

Tools—Flange Plate #D-127-2, Installing Ring #D-127-1, Forcing Plate #D-127-4, Bolts #SP-5026, Washers #SP-3020.

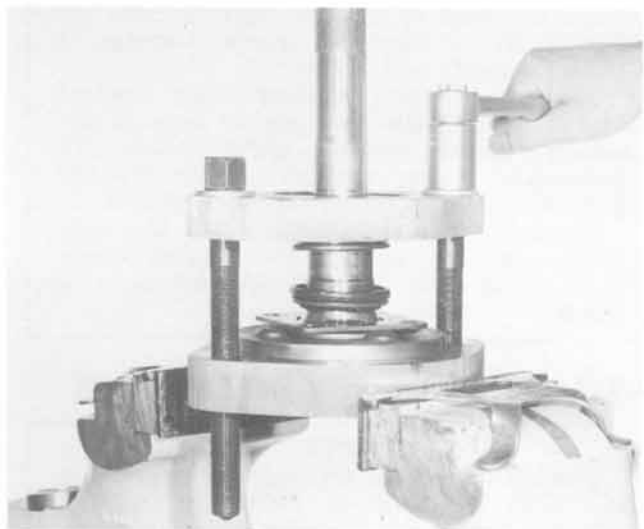


Figure 94

1008-94

Tighten bolts alternately and evenly making sure bearing is not cocked on axle shaft. Continue until unit wheel bearing is seated. To make sure bearing is seated, use a .0015" feeler gage between bearing seat and bearing. If gage enters, force bearing further on the axle shaft, until gage does not enter.

To install retainer ring on axle shaft, follow the same procedures as illustrated in Figures 93 and 94.

Use a .0015" feeler gage between the bearing and retainer ring to be sure that the retainer ring is seated. At least one point should exist, where the gage will not enter between the retainer ring and bearing. If gage enters completely around the diameter, retainer ring must be forced further onto the axle shaft.

To assemble axle shaft assembly into housing, follow steps as illustrated in Figures 71 through 75.

### LUBRICATING NEW UNIT BEARING WITH GREASE

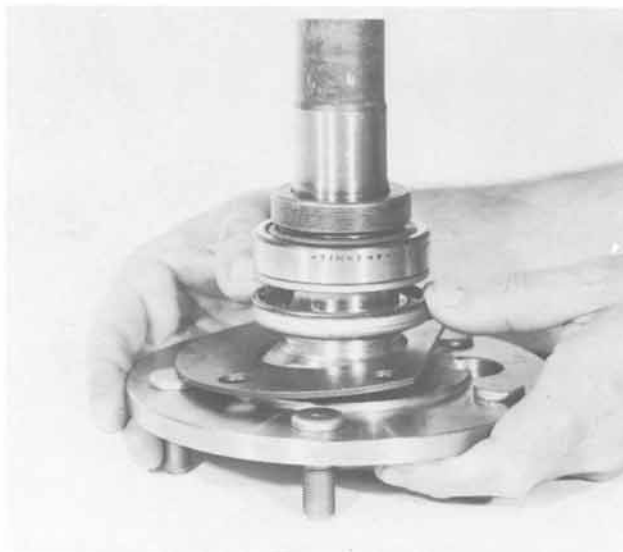


Figure 95

1008-95

Push seal and retainer away from bearing to allow a cavity between the seal and bearing.

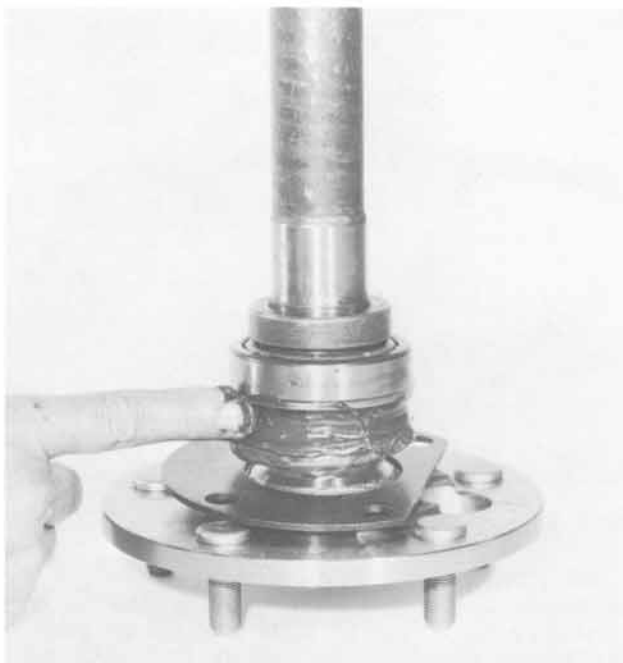


Figure 96

1008-96

Fill cavity with a good quality number 2 E.P. (extreme pressure), lithium soap, wheel bearing grease.



## REAR AXLE

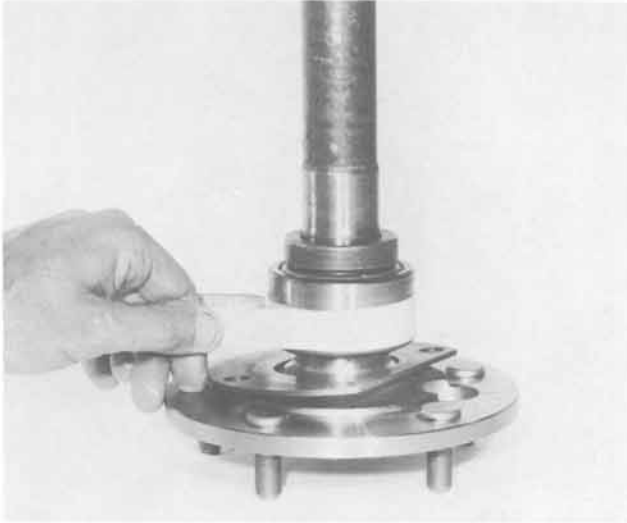


Figure 97

1008-97

After cavity is full of grease, wrap tape completely around rib ring, and seal to enclose the cavity.

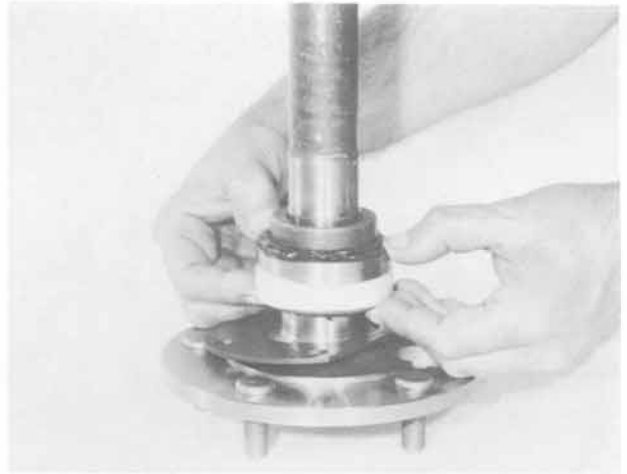


Figure 98

1008-98

Push seal towards the bearing until it contacts the rib ring. This will force the grease between the rollers and cup.

### NOTE

If grease is not apparent on the small ends of the rollers, repeat the same steps until grease is evident between the small end of the roller and cup. **Remove tape.**

## CARRIER SECTION

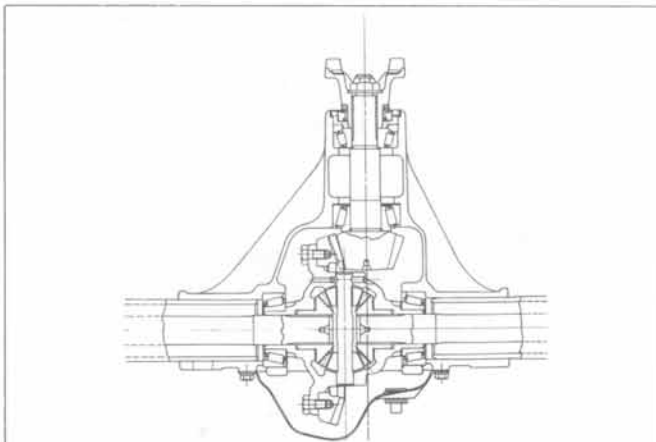


Figure 99

1008-99

L/D Carrier.

### DISASSEMBLY

#### NOTE

If it becomes necessary to disassemble any parts inside the carrier, it is suggested that the entire axle be removed from the vehicle and held tight in a stand or rack.

Remove drain plug and drain lubricant. If there is no drain plug in the carrier, the lube will drain out as the cover plate is removed.



Figure 100

1008-100

Remove cover plate screws, cover plate, and cover plate gasket. **Discard old gasket.** Tip carrier to allow lube to drain completely.

Also during this time clean the cover face of the carrier, making sure it is free from any nicks and any particles left by the old gasket.

## CARRIER SECTION

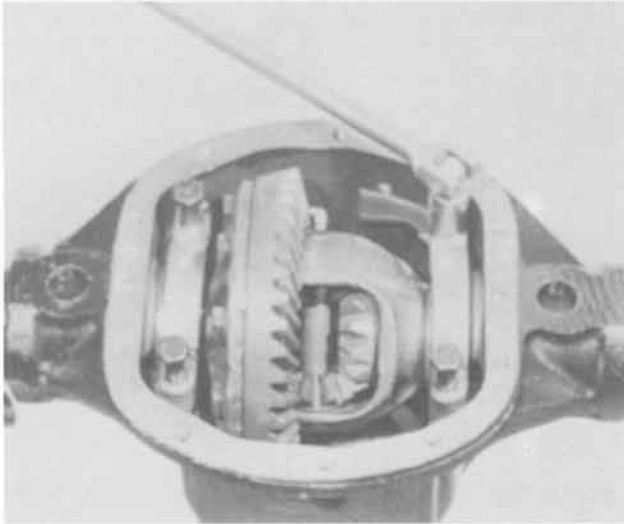


Figure 101

1008-101

Remove bearing caps. Note mating letters stamped on caps and carrier. This is important at time of assembly as they are to be assembled exactly as removed. Letters or numbers are in horizontal and vertical position.

### CAUTION

Before removing differential case and ring gear, make sure the axle shafts are pulled out far enough for clearance to remove differential.

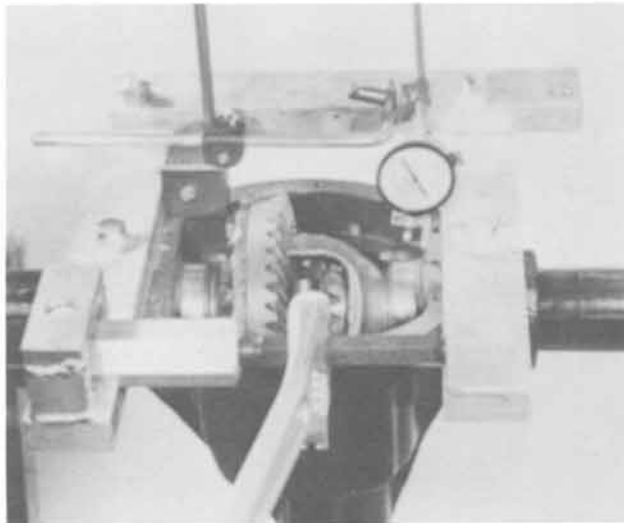


Figure 102

1008-102

Mount spreader to housing. **Do not spread carrier over .015"**. Use dial indicator as shown. **Note:** This spreader can also be used on the Spicer Model 44 axle.

Tools—Spreader D-113, and Indicator Set D-128.

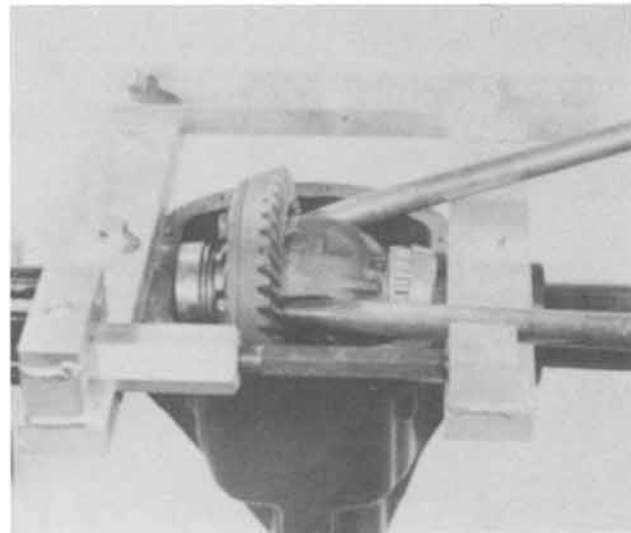


Figure 103

1008-103

Pry differential case from carrier with two pry bars as shown. **After differential case has been removed, remove spreader.** Use caution to avoid damage to ring and pinion. Mark on tag bearing cups indicating from which side they were removed.

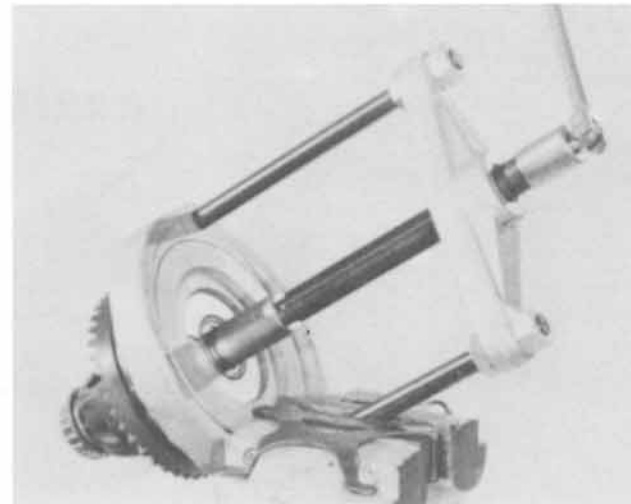


Figure 104

1008-104

Remove differential bearings with a puller as shown. Wire shims, bearing cup and bearing cone together. Identify from which side they were removed (ring gear side or opposite side). If shims are mutilated replace with new shims at the time of assembly. Shims are available in thicknesses of .003", .005", .010", and .030". Reposition case in puller and remove other bearing cone as described above.

Tools—Press and adapter ring DD914-9P, Plug #SP-3289, Adapter Set C-293-39.

### NOTE

It is recommended that whenever bearings are removed they are (regardless of mileage) to be replaced with new ones.

## CARRIER SECTION



Figure 105

1008-105

Place a few shop towels over the vise to prevent the ring gear teeth from being nicked after it is free from the case.

Place case in vise. Remove ring gear screws. Tap ring gear with a rawhide hammer to free it from the case. Remove case and ring gear from vise.

### NOTE

It is recommended that whenever the ring gear screws are removed, they are to be replaced with new ones.



Figure 106

1008-106

Replace case in vise and drive out lock pin which secures the pinion mate shaft. Use a small drift as shown.

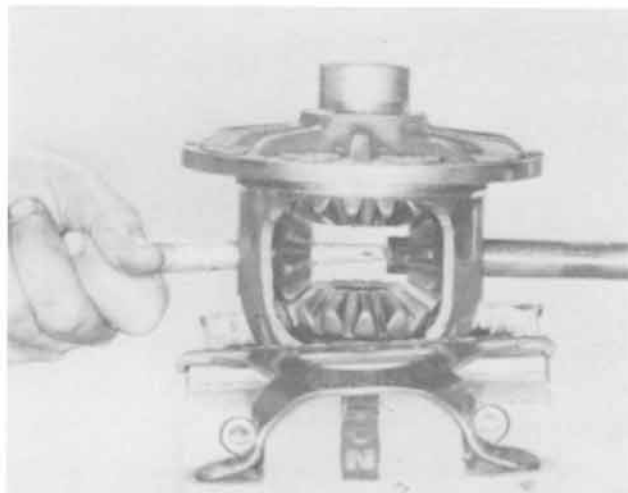


Figure 107

1008-107

Remove pinion mate shaft with drift as shown.



Figure 108

1008-108

To remove side gears and pinion mate gears, rotate the side gears. This will allow the pinion mate gears to turn to the opening of the case. Remove pinion mate gears and also the spherical washers behind the gears. Lift out gears and thrust washers. Inspect all parts, including the machined surfaces of the case itself. Where necessary replace all worn parts. If excessive wear is visible on all parts, it is suggested that the complete differential assembly be replaced. If any one of the gears are to be replaced, **They are to be replaced as a set.**

### NOTE

Axle shafts which require end play adjustment have a spacer block in the differential case. The spacer block controls the end thrust of the axle shaft. If the ends of the spacer block are worn, it is to be replaced during assembly. Spacer block must not be used with ball or unit wheel bearings.

## CARRIER SECTION

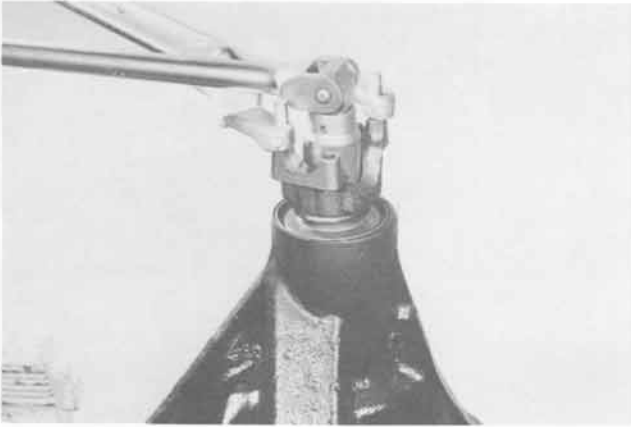


Figure 109

1008-109

Turn nose of carrier in a horizontal position to remove pinion nut. Hold end yoke or flange with tool similar to the one shown, and remove pinion nut and washer.

Tool—#C-3281 Holding Wrench.

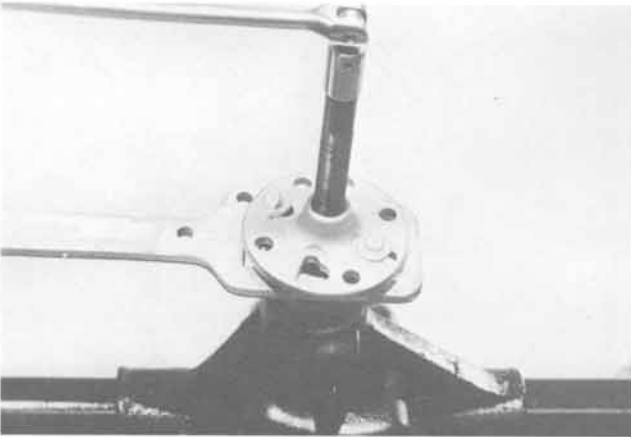


Figure 110

1008-110

Remove end yoke or flange with tools as shown. If yoke or flange shows wear in the area of the seal contact, it should be replaced.

Tool—C-452 Remover—Yoke.

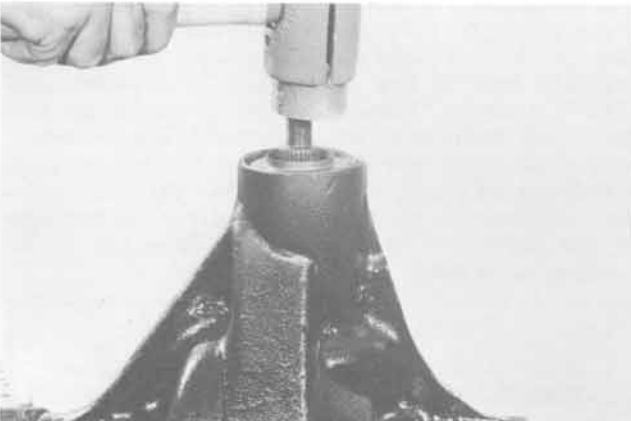


Figure 111

1008-111

Remove pinion by tapping with a rawhide hammer. Catch the pinion with your hand to prevent it from falling to the ground and being damaged.

### NOTE

On the spline end of the pinion, there are bearing preload shims. These shims may stick to the bearing - pinion - or even fall out. The shims are to be collected and kept together since they will be used later in assembly. Try not to mutilate shims. If shims are mutilated, replace with new ones. Shims are available in thicknesses of .003", .005", .010", and .030".

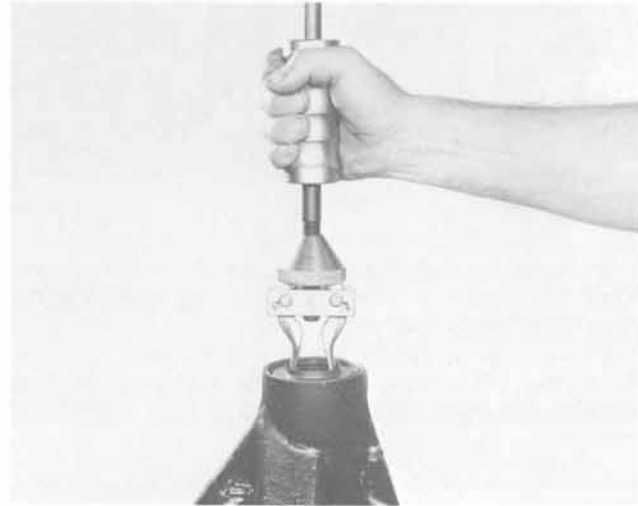


Figure 112

1008-112

Pull out pinion seal with puller as shown. Discard seal. Replace with new seal at time of assembly. Remove bearing cone and outer pinion oil slinger.

Tools—Slide Hammer #D-131.

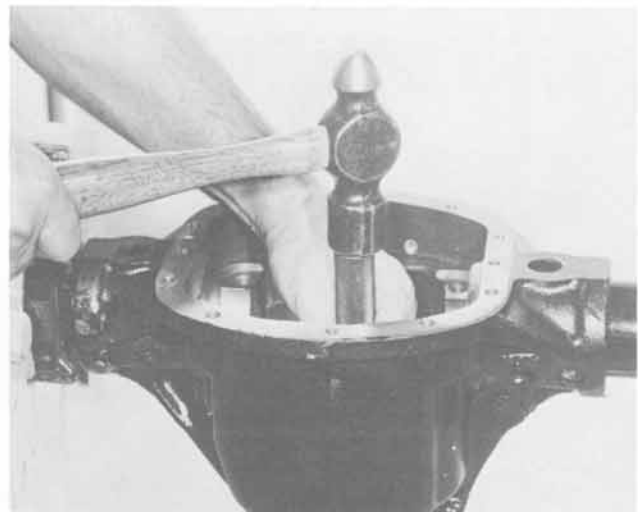


Figure 113

1008-113

Turn nose of carrier down. Remove outer pinion bearing cup as shown. Locate driver on back edge of cup, drive cup out of carrier. **Caution: Do not nick carrier bore.**

Tools—D-147 Remover, C-4171 Handle.

# CARRIER SECTION

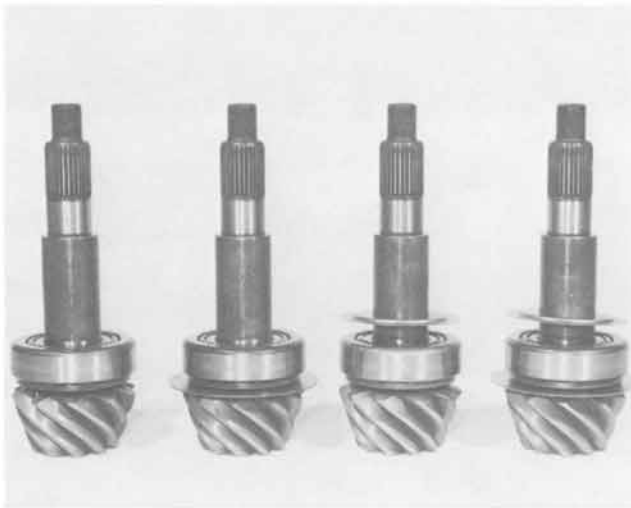


Figure 114

1008-114

### NOTE

The front and rear axle carrier section may vary in pinion bore depth due to the possibility of the need for either a baffle or slinger or both.

The baffle serves the same purpose of assisting the lube to flow up through the oil channels to lubricate the pinion bearings. If used, they are part of the pinion setting adjustment. In Figure 114 we show the four different options.



Figure 115

1008-115

Remove the inner bearing cup with tools as shown.

Tools—D-149 Remover, C-4171 Handle.

### NOTE

Shims are located between the bearing cup and carrier bore, and, as illustrated in Figure 114 may also include an oil baffle. If shims and baffle are bent or nicked they should be replaced at time of assembly. Wire the stacks together and measure each. If stack has to be replaced, replace with the same thickness.



Figure 116

1008-116

Remove inner pinion bearing with tools as shown.

Tools—DD-914P Press, DD-914-9 Adapter Ring, C-293-39 Adapter Set.

### NOTE

Both baffle and slinger are part of the pinion adjustment shims and are to be kept intact for assembly.

### ASSEMBLY

On all front axles there are axle shaft oil seals which are pressed into the tube ends of the carrier. There are two different designs.

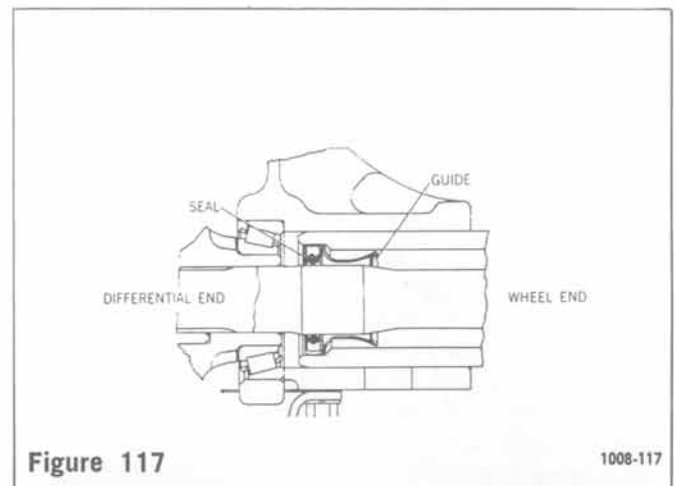
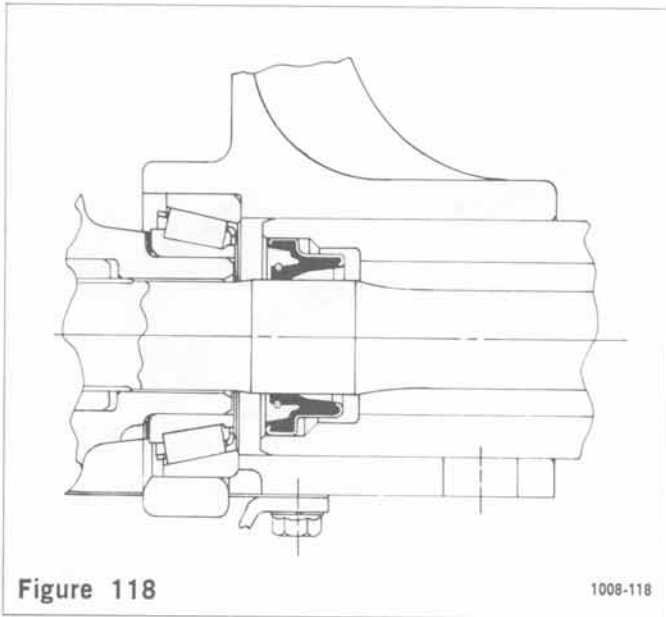


Figure 117

1008-117

As shown in Figure 117 this design consists of an axle shaft guide and seal. (One guide and one seal for each side.)

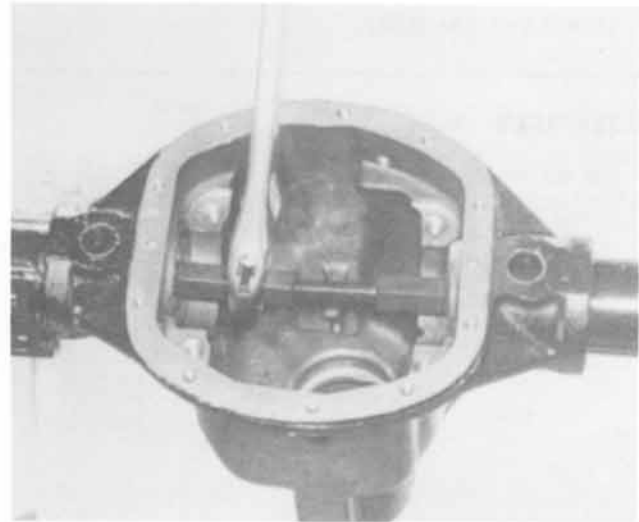
## CARRIER SECTION



**Figure 118**

1008-118

As shown in Figure 118, this design consists of the integral seal (unit) whereby the seal and guide are combined. (One seal for each side)



**Figure 119**

1008-119

Assemble inner axle shaft seals and guides. To assemble axle shaft guides and seals as shown in Figure 117, use tools as described.

Tools—#D-112 Screw, #D-112-4 Adaptors.

To assemble axle shaft seals as shown in Figure 118, use Tools as described.

Tools—#D-112 Screw, #D-112-5 Adaptors.

When assembling the seals make sure they are positioned straight and do not get cocked.

Turn forcing screw until it stops, seal will then be seated.

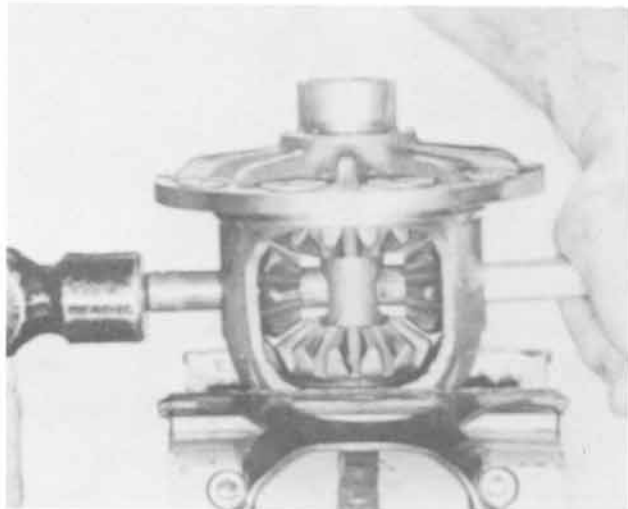


**Figure 120**

1008-120

Place differential case in vise as shown. Apply grease to new side gear thrust washers and hubs of side gear. Assemble both side gears. Apply grease to new pinion mate spherical washers and the pinion mate gears. Assemble pinion mate gears. An easy way to assemble the side gears and pinion mate gears is to have all parts lubricated before assembly. Assemble both side gears and thrust washers, hold them in place with hand, then assemble the pinion gears to hold the side gears in place.

Rotate the side gears until the holes of the washers and pinion gears line up with the holes of the case. If the gears cannot be rotated by hand, install one of the axle shafts into the side gear spline and use a pipe wrench to turn the shafts.



**Figure 121**

1008-121

If spacer block is used, assemble as shown. Use a drift to line holes of the gears up with the case. Assemble shaft, drive on shaft to remove drift. Be sure vertical lock pin hole is lined up with that of the case, and that the pinion mate spherical washers are in place, and lined up with gear and case.



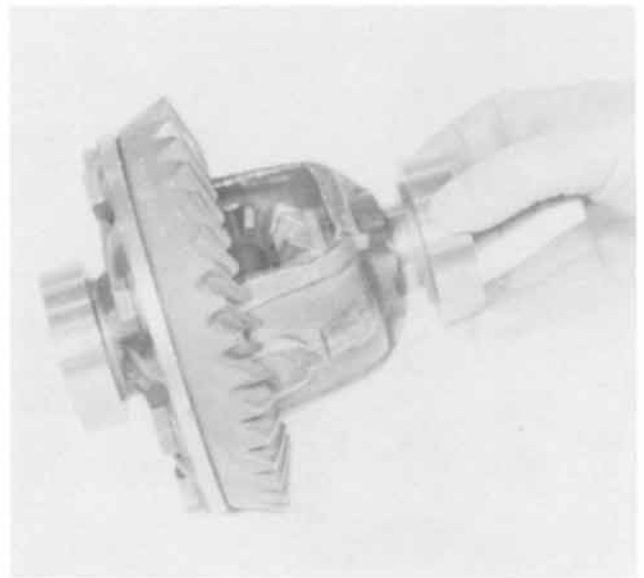
# CARRIER SECTION



**Figure 122**

1008-122

Assemble lock pin. Peen metal of case over pin to lock in place.

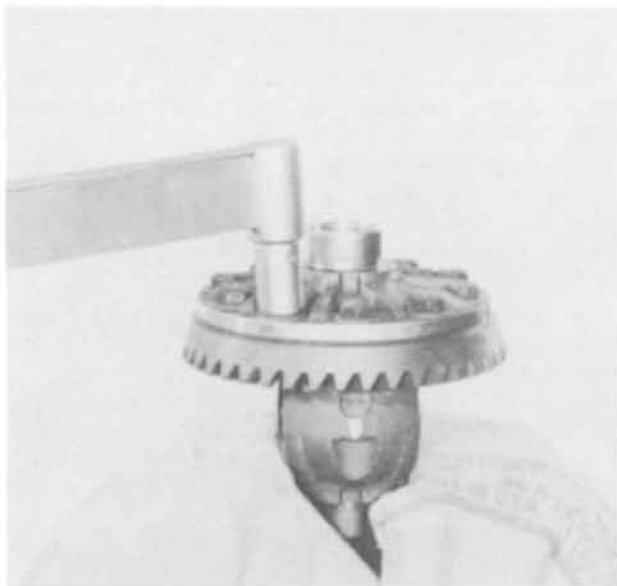


**Figure 124**

1008-124

Install master differential bearing onto case. Remove all nicks, burrs, dirt, etc. from hubs to allow master bearings to rotate freely.

Tools—Master Bearings #D-134.



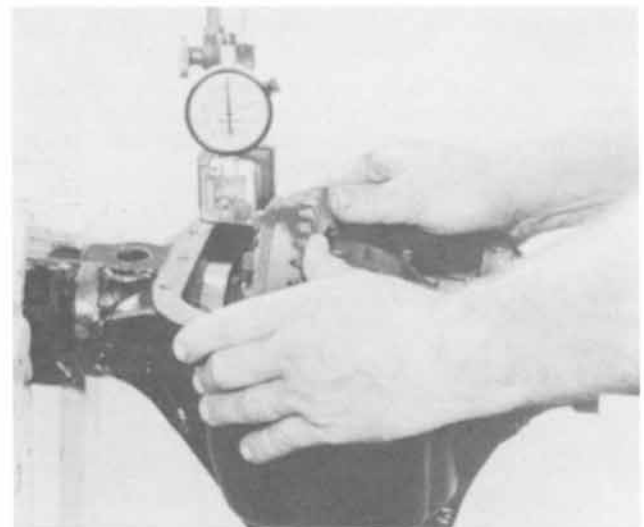
**Figure 123**

1008-123

Be sure flange face of the case is free of nicks or burrs. Assemble ring gear to case **using new ring gear screws**. Line up holes of gear and case. Draw up screws alternately and evenly.

Torque screws to 45-60 lbs. ft.

Tool—C524-A Torque Wrench.



**Figure 125**

1008-125

Assemble differential case into carrier (less pinion). Mount dial indicator, with a magnetic base as shown. Locate tip of indicator on flat surface of one of the gear screws. Mark screw with a piece of chalk. Force the differential assembly as far as possible in the direction towards the indicator. With force still applied, set indicator at zero. (0).

Tool—Indicator #D-128.

## NOTE

Indicator should have a minimum of .200" travel.

## CARRIER SECTION

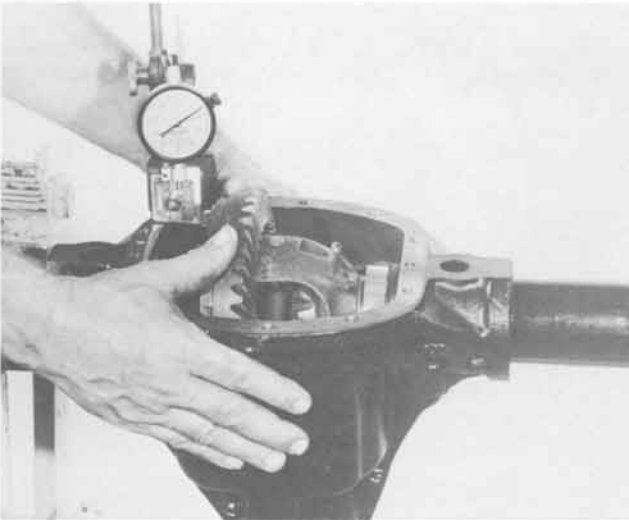


Figure 126

1008-126

Force the differential assembly as far as it will go in the opposite direction. Repeat these steps until the same reading is obtained.

Record the reading of the indicator.

This will be the total amount of shims required (less preload) and will be calculated later during assembly.

After making sure the readings are correct, remove indicator and differential assembly from housing. **Do not remove master bearings from differential case at this time.**

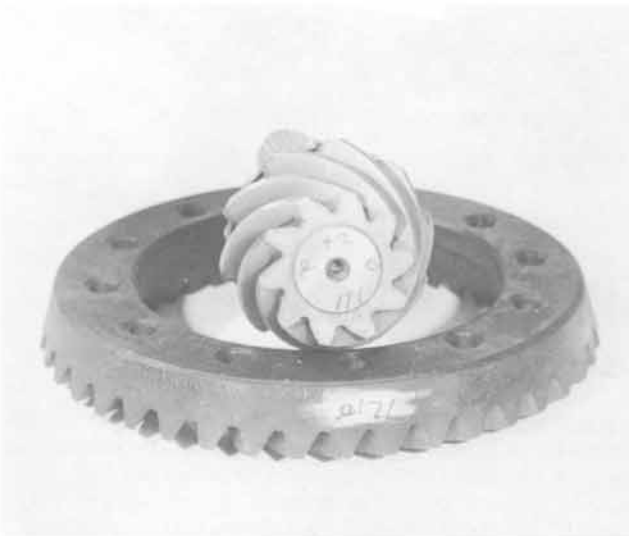


Figure 127

1008-127

View of ring and pinion set.

Ring gears and pinions are supplied in matched sets only. Matching numbers on both the pinion and ring gear are etched for verification. If a new gear set is being used, verify the numbers of each pinion and ring before proceeding with assembly.

The distance from the centerline of the ring

gear to the button end of the pinion for the Model 30 (front and rear) axle is 2.250 inches.

On the button end of each pinion there is etched a plus (+) number, a minus (—) number, or a zero (0) number, which indicates the best running position for each particular gear set. This dimension is controlled by the shimming behind the inner bearing cup.

For example — if a pinion is etched +3, this pinion would require .003" less shims than a pinion etched "0". This means by removing shims, the mounting distance of the pinion is increased to 2.253" which is just what a +3 indicates. Or if a pinion is etched —3, we would want to add .003" more shims than would be required if the pinion were etched "0". By adding .003" shims the mounting distance of the pinion was decreased to 2.247" which is just what a —3 etching indicated.

If the old ring and pinion set is to be reused, measure the old shim pack and build a new shim pack to this same dimension. If a baffle is in the axle assembly, it is considered as part of the shim pack.

To change the pinion adjustment, shims are available in thicknesses of .003", .005" and .010".

### NOTE

If baffle or slinger is bent or mutilated, it should be replaced.

Measure each shim separately with a micrometer and add together to get total shim pack thickness from original build up.

If a new gear set is being used, notice the (+) or (—) etching on both the old and new pinion and adjust the thickness of the new shim pack to compensate for the difference of these two figures.

For example: If the old pinion reads (+) 2 and the new pinion is (—) 2, add .004" shims to the original shim pack.

The above procedures also apply to pinion adjustment on the front axle which includes the oil slinger between the inner bearing cone and pinion, and baffle between the inner bearing cup and carrier.

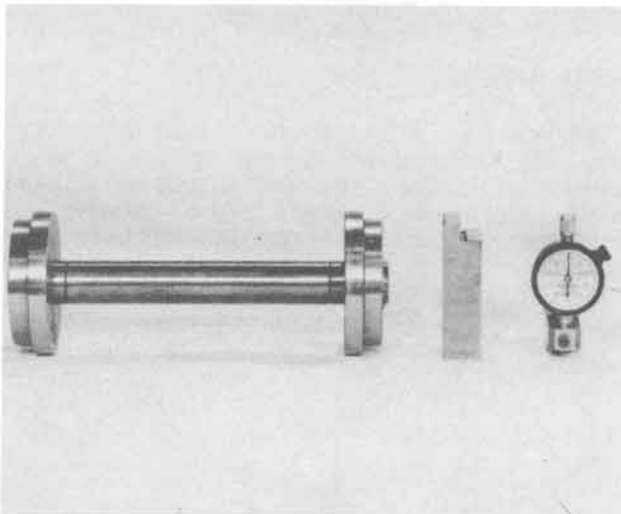
# CARRIER SECTION

Old Pinion Marking	New Pinion Marking								
	-4	-3	-2	-1	0	+1	+2	+3	+4
+4	+0.008	+0.007	+0.006	+0.005	+0.004	+0.003	+0.002	+0.001	0
+3	+0.007	+0.006	+0.005	+0.004	+0.003	+0.002	+0.001	0	-0.001
+2	+0.006	+0.005	+0.004	+0.003	+0.002	+0.001	0	-0.001	-0.002
+1	+0.005	+0.004	+0.003	+0.002	+0.001	0	-0.001	-0.002	-0.003
0	+0.004	+0.003	+0.002	+0.001	0	-0.001	-0.002	-0.003	-0.004
-1	+0.003	+0.002	+0.001	0	-0.001	-0.002	-0.003	-0.004	-0.005
-2	+0.002	+0.001	0	-0.001	-0.002	-0.003	-0.004	-0.005	-0.006
-3	+0.001	0	-0.001	-0.002	-0.003	-0.004	-0.005	-0.006	-0.007
-4	0	-0.001	-0.002	-0.003	-0.004	-0.005	-0.006	-0.007	-0.008

**Figure 128**

1008-128

Pinion setting chart shown. Use this chart as a guideline to set pinion.



**Figure 129**

1008-129

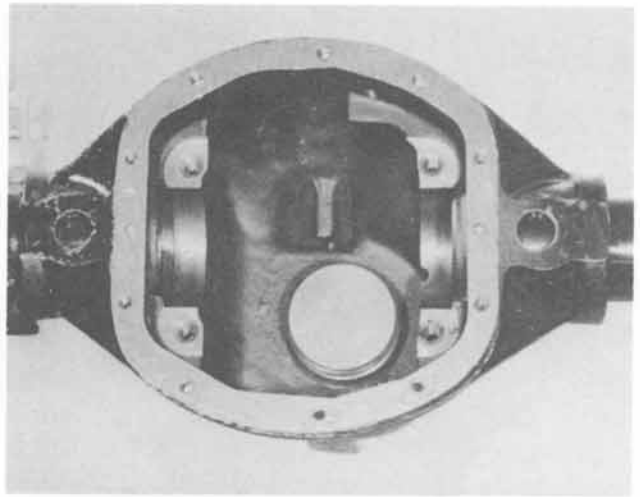
View of master pinion block, pinion height block, scooter gage, cross arbor, and master bearing discs.

**NOTE**

Cross arbor and master bearing discs can be used on both the model 30 and model 44 axles. Use small diameter discs for model 30 axles.

**NOTE**

Be sure that all carrier bores are free from all nicks, dirt or any other contamination.

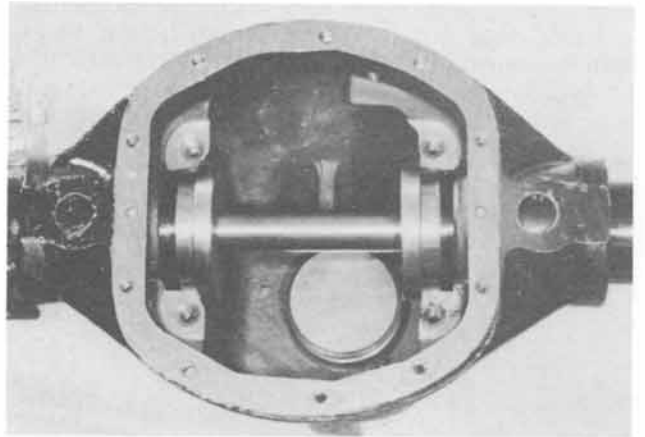


**Figure 130**

1008-130

Place the master pinion block into the pinion bore of the carrier as shown.

Tool—Master Pinion Block #D-138.

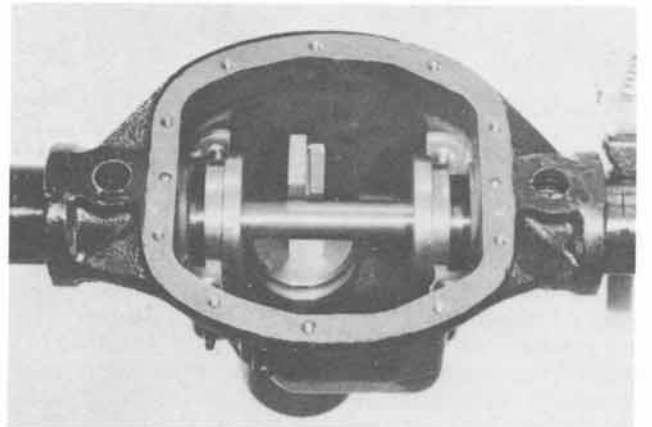


**Figure 131**

1008-131

Place arbor discs and arbor into cross bores of the carrier as shown.

Tools—Arbor #D-115-3, Arbor Discs #D-115-4.



**Figure 132**

1008-132

Place pinion height block on top of master pinion block, and against arbor as shown.

Tools—Pinion Height Block #115-1.

## CARRIER SECTION

If a pinion is etched  $-3$ , we would want to add  $.003$ " more shims that would be required if the pinion were etched zero "0".

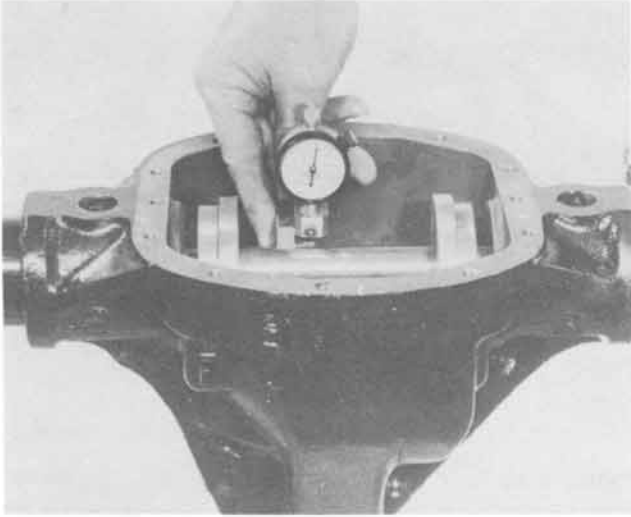


Figure 133

1008-133

Place scooter gage on small step of pinion height block. Apply pressure with fingers making sure the gage is flat on the pinion height block, while pressure is applied, set indicator at zero "0".

Tool—Scooter Gage #D-115.

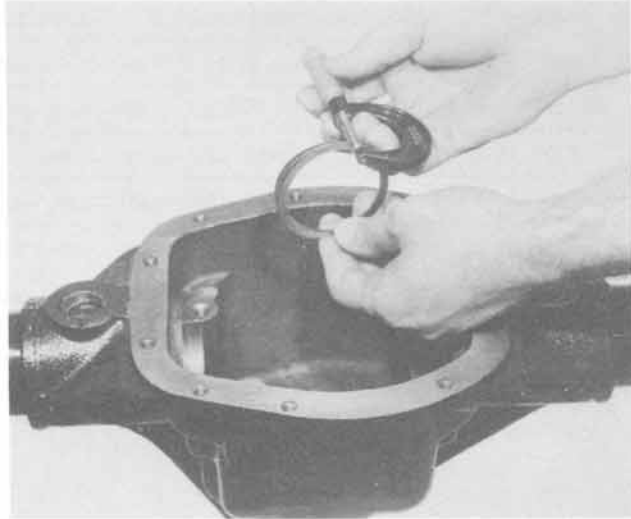


Figure 135

1008-135

Measure each shim separately with a micrometer and add together to get total shim pack thickness. If baffle is required, it is to be included in the shim pack. If slinger is used between the inner bearing cone and thrust face of pinion, the slinger is also to be measured and included as a part of the total shim pack.

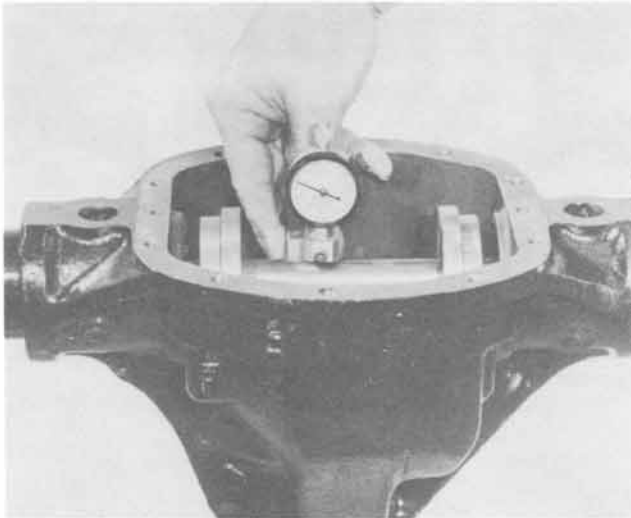


Figure 134

1008-134

Slide scooter gage over arbor. As gage slides over top of arbor, it will travel in a clockwise direction. When indicator is on center of arbor (on top) it will stop traveling in a clockwise direction. If indicator starts to travel in a counter-clockwise direction, this means that you have passed the center (top) of the arbor. Record only the reading when the indicator is at the highest point. This reading indicates the amount of shims necessary to obtain the correct shim pack, plus (+) or minus (—) the etching on the button end of the pinion. If the etching is zero (0) the shim pack will remain unchanged.

For example: If a pinion is etched  $+3$  this pinion would require  $.003$ " less shims than a pinion etched zero "0".

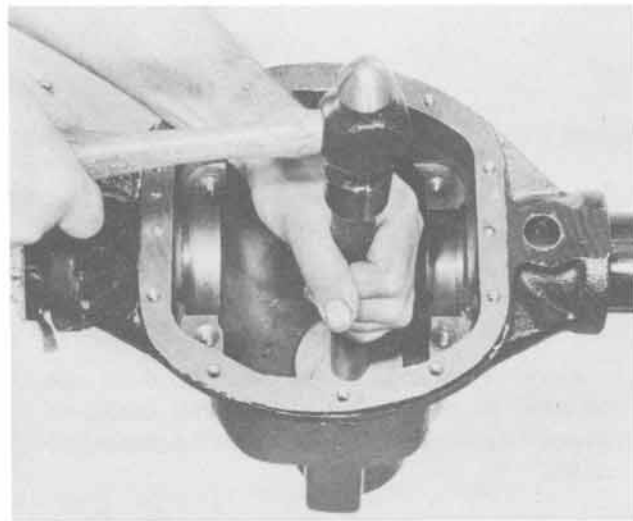


Figure 136

1008-136

Place the required amount of shims (and baffle if used) in the inner bearing bore, drive the inner bearing cup into carrier with tools as shown.

Tools—D-146 Cup Installer, C4171 Handle.

## CARRIER SECTION

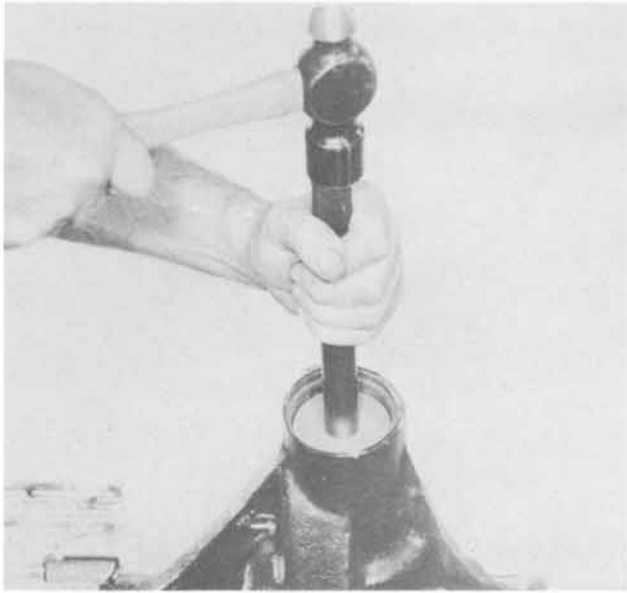


Figure 137

1008-137

Assemble the outer pinion bearing cup into carrier as shown.

Tools—D-144 Cup Installer, C4171 Handle.

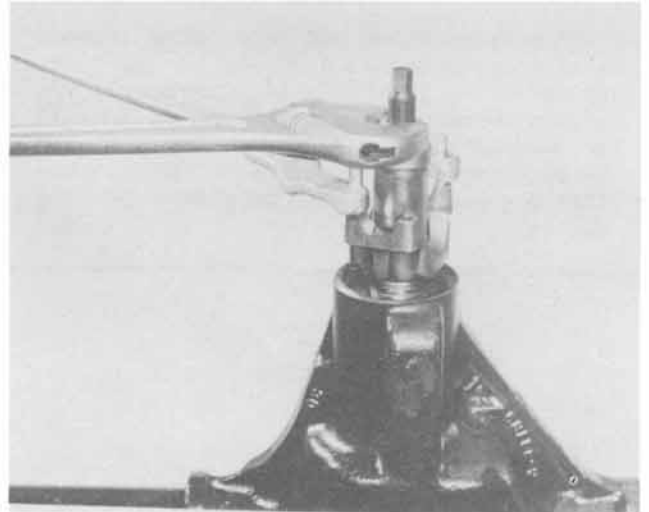


Figure 139

1008-139

Install pinion into carrier.

Assemble outer pinion bearing cone, (slinger if used) and end yoke onto pinion spline.

### NOTE

Do not assemble preload shims or pinion oil seal at this time.

Use yoke installer (as shown) to assemble end yoke onto spline of pinion.

Tool—Installer W-162, Holder #C-3281.

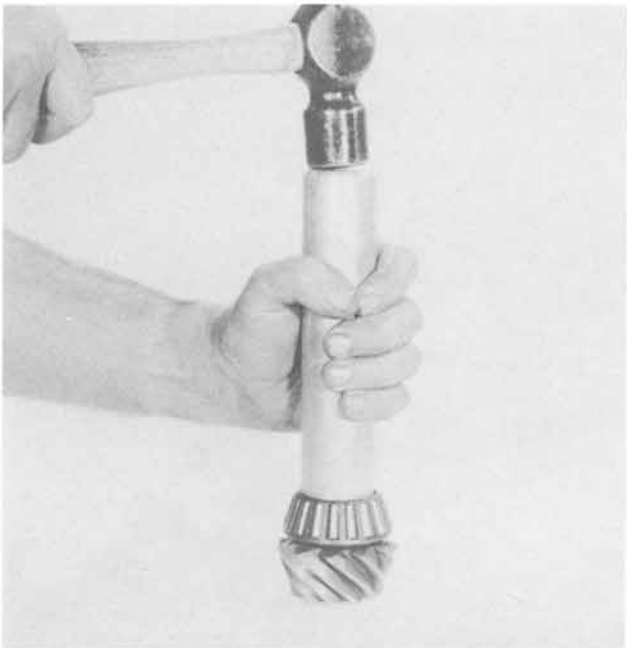


Figure 138

1008-138

Assemble inner bearing cone (and slinger if used) on pinion, place bearing installer over pinion shaft as shown. Drive bearing on shaft until it is completely seated.

Tool—W-262.

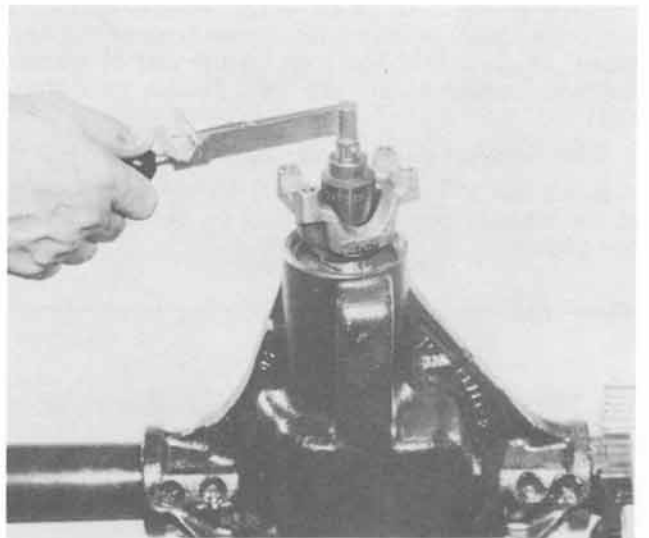


Figure 140

1008-140

Assemble washer and pinion nut. Torque nut until it requires 10 lbs. inch to rotate pinion. Rotate pinion several times before checking pinion position. This is to seat the bearings and assure a more accurate reading of pinion depth setting.

Tool—C-685-A Inch lb. Wrench.

## CARRIER SECTION

### NOTE

The reason for not assembling preload shims and new pinion oil seal at this time, is due to the possibility of having to adjust pinion preload or pinion adjustment. It would be necessary to again remove the seal, and as mentioned, whenever seals are removed they are to be discarded, because of possible damage.

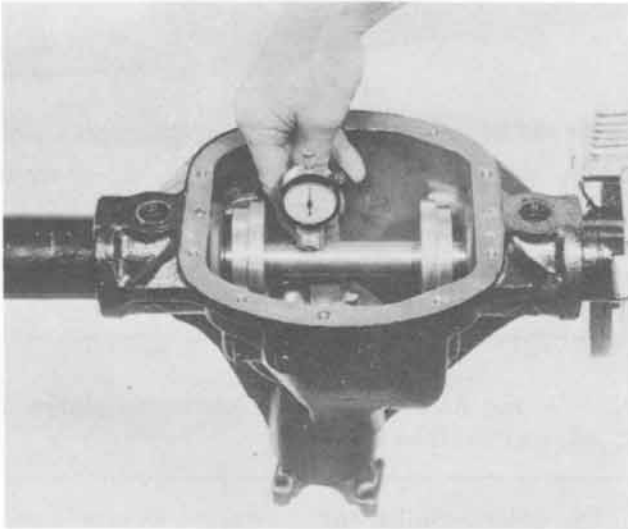


Figure 141

1008-141

Place arbor and arbor discs (small diameter discs for Model 30 axle) into cross bore of carrier. Place pinion height block on button end of pinion. Set dial indicator on zero "0". (Refer to Figure 134).

Slide scooter gage across or over arbor.

Indicator will read a plus (+) or minus (-) at its highest point, depending on the etching of the pinion.

### NOTE

Indicator reading within .002 of etching is considered acceptable.

If pinion position is found to be within specifications continue with build up. If pinion position is not within specifications, change shim pack thickness under inner bearing cup.

Remove pinion nut, washer, end yoke, slinger, and bearing cone. Assemble preload shims (which were removed during disassembly) onto pinion. Assemble bearing cone, slinger.

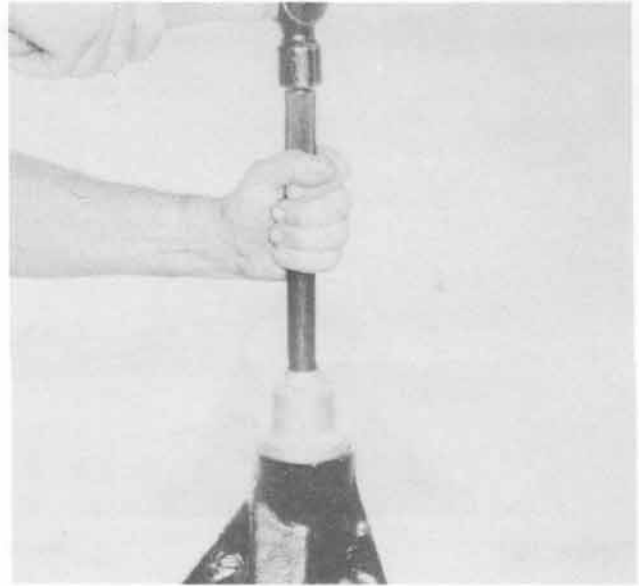


Figure 142

1008-142

Apply a light coat of hypoid lubricant to the lip of the pinion seal and assemble into housing.

Tools—#W-147D Seal Installer, C4171 Handle.

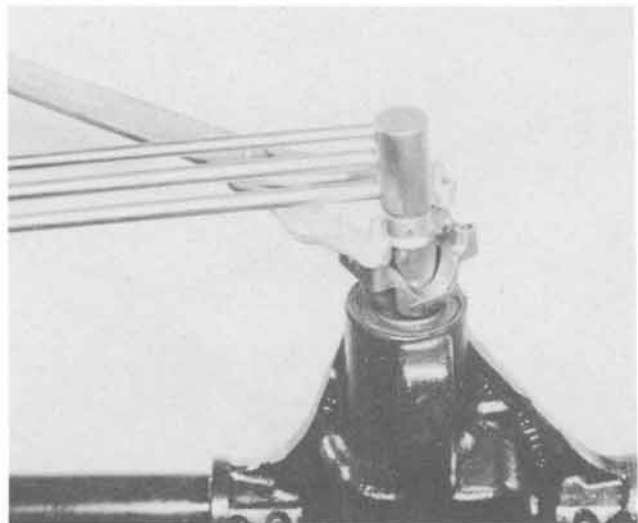


Figure 143

1008-143

Assemble end yoke, washer, and pinion nut. Torque nut to 200-220 lbs. ft.

Tools—#C-4053, Torque Wrench, C-3281 Yoke Holder.



# CARRIER SECTION

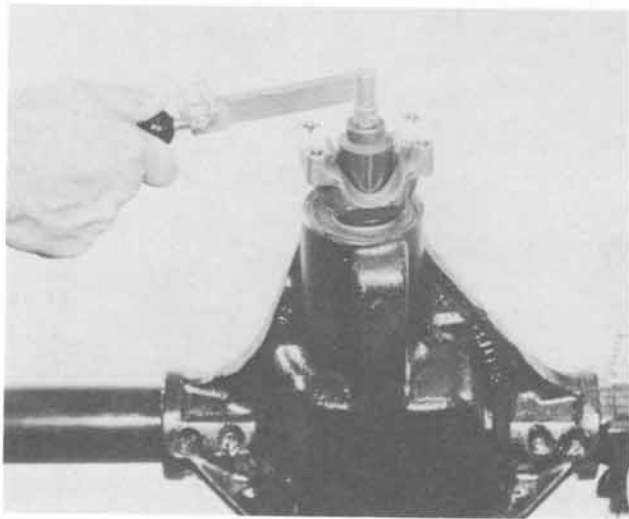


Figure 144

1008-144

Using an inch lb. torque wrench as shown, rotate pinion. Torque of pinion should read between 20-40 lbs. inch.

To increase preload remove shims, to decrease preload add shims.

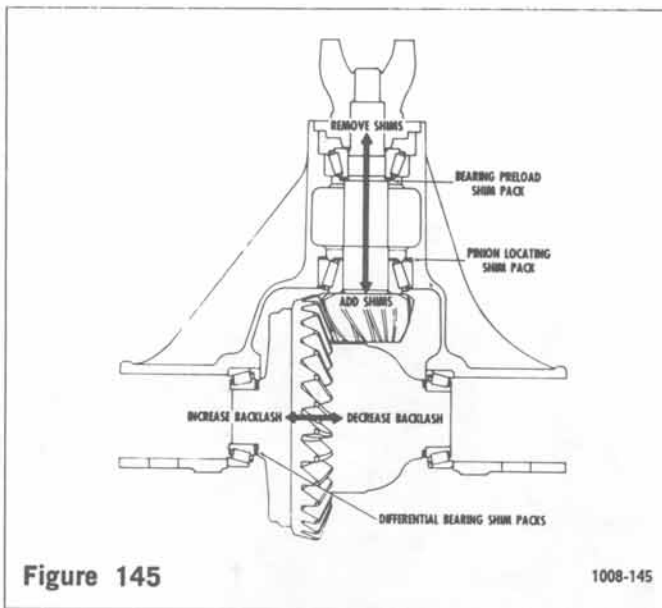


Figure 145

1008-145

## L/D Carrier section.

The illustration in Figure 145 shows the arrow in the pinion pointing in two directions. The direction of the arrow pointing towards the end yoke indicates that by removing pinion locating shims, the distance from the center line of the axle to pinion button, is increased giving a plus reading. The preload shim pack do not affect the pinion depth setting.

Arrows on the ring gear illustrate the method to increase or decrease backlash, and differential bearing preload.

## ASSEMBLY OF DIFFERENTIAL

Place differential assembly (with pinion assembled) into housing. Differential master bearings should still be installed to differential case.

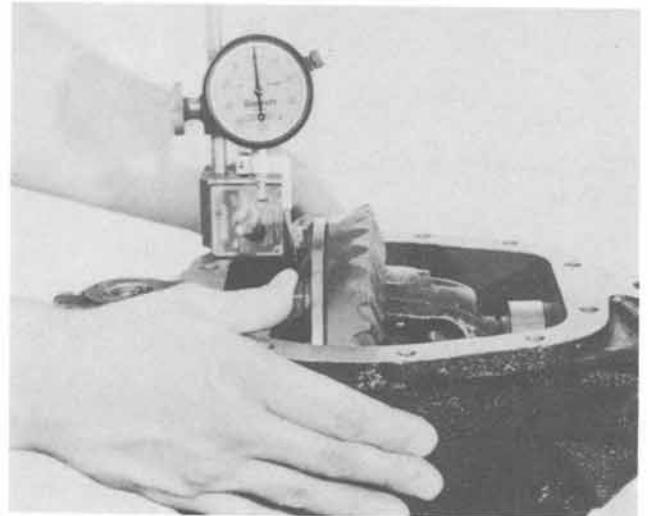


Figure 146

1008-146

Set up dial indicator as shown. Be sure to locate dial indicator on same ring gear screw as shown in Figure 125. Force ring gear to mesh with pinion gear. Rock ring gear to allow the teeth of the gears to mesh. With force still applied to the differential case, set indicator at zero "0".

Tool—Indicator #D-128.

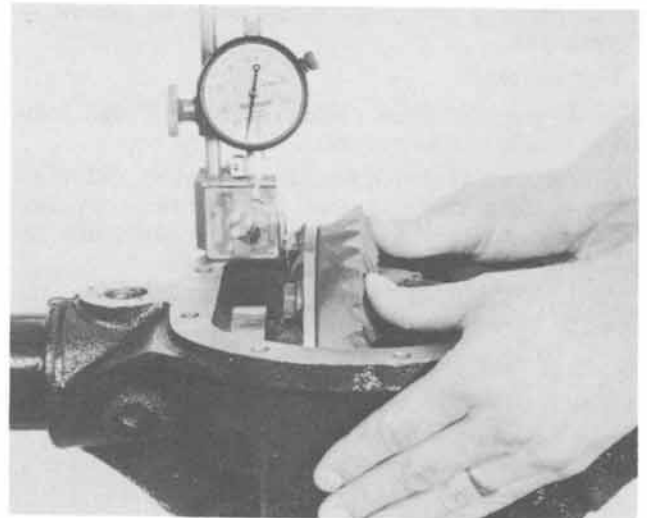


Figure 147

1008-147

Force the differential assembly (ring gear) away from the pinion gear, to obtain an indicator reading. Repeat until the same reading is obtained each time. This reading will be the necessary amount of shims between the differential case and differential bearing on the ring gear side. Remove indicator and differential case from the carrier.

Remove master bearings from differential case.



## CARRIER SECTION

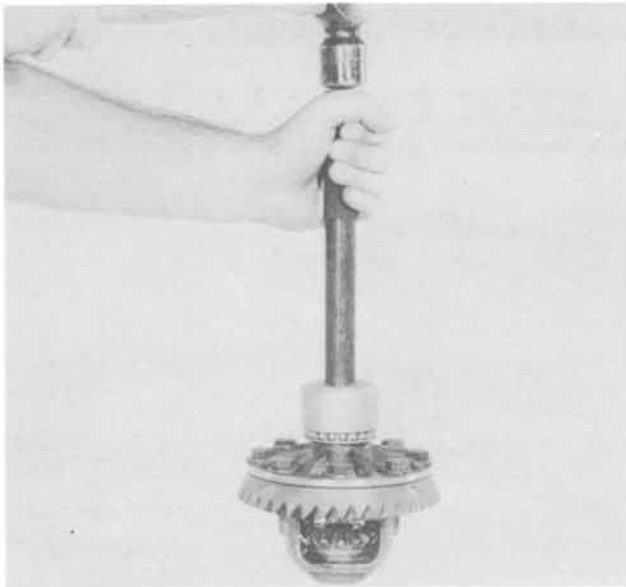


Figure 148

1008-148

Assemble the required amount of shims onto hub (ring gear side) as determined in Figure 147. Place bearing cone on hub of case. Use bearing installer to seat bearing cone as shown. Step plate is used to prevent possible damage to hubs, while assembling bearings.

Tools—Installer #C3716-A, Handle #C4171.

Assemble the remaining of the total shim pack which was determined in Figure 126 on the opposite side of the differential case. Add an additional .015 of shims on this side to compensate for differential bearing preload. Assemble differential bearing using the same tools as shown in Figure 148.

For example:

In Figure 126 (less pinion) a total of .085 indicator reading was recorded.

In Figure 147 (with pinion) a total of .055 indicator reading was recorded. This leaves a balance .030 of shims for the opposite side and adds up to the .085 which was first recorded.

Add an additional .015 shims on the opposite side for bearing preload and backlash.

Ring Gear Side .055.

Opposite Side .030.

Opposite Side Preload .015.

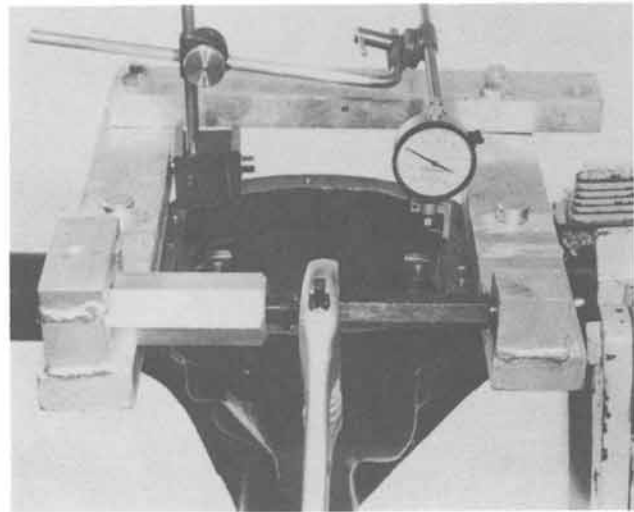


Figure 149

1008-149

Install spreader and indicator to carrier as shown. Do not spread carrier over .015". Remove indicator.

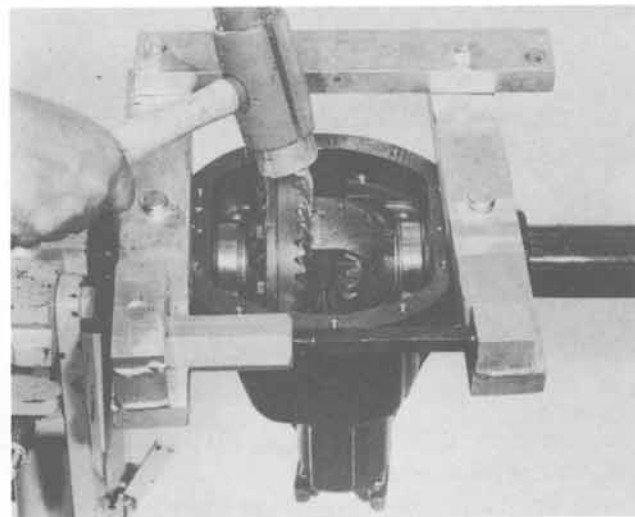


Figure 150

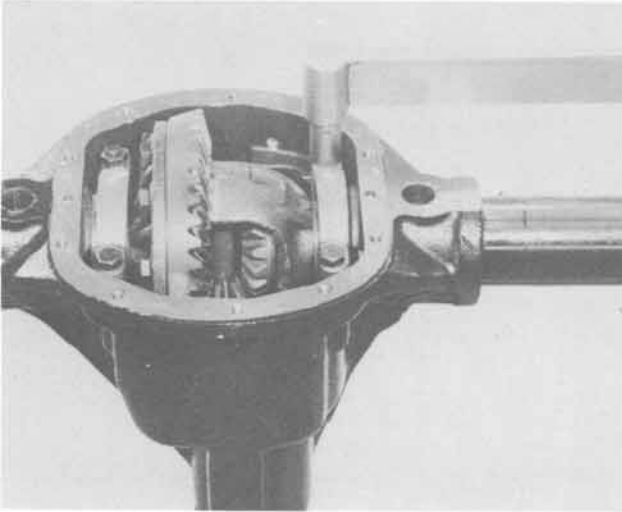
1008-150

Assemble differential bearing cups to differential bearing cones.

Install differential assembly into carrier.

Use a rawhide hammer to seat differential assembly into cross bore of carrier. Care should be taken to avoid nicking the teeth of the ring gear and pinion during assembly.

## CARRIER SECTION

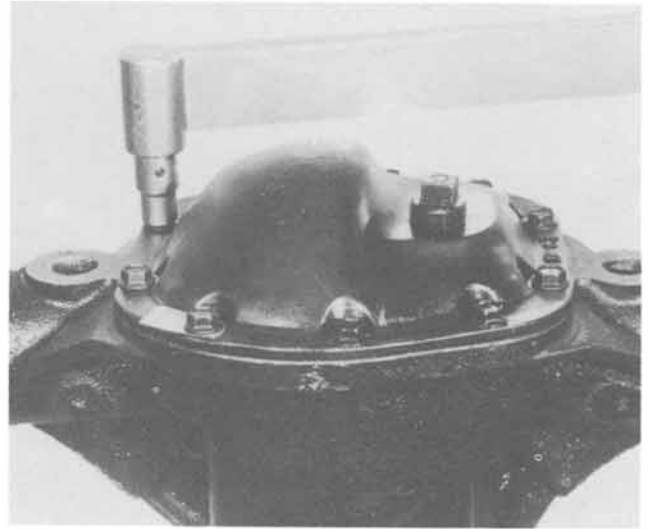


**Figure 151**

1008-151

Install bearing caps. Make sure the letters stamped on the caps correspond with those on the carrier torque bearing cap screws to 35-50 lbs. ft.

Tool—C524-A Torque Wrench.

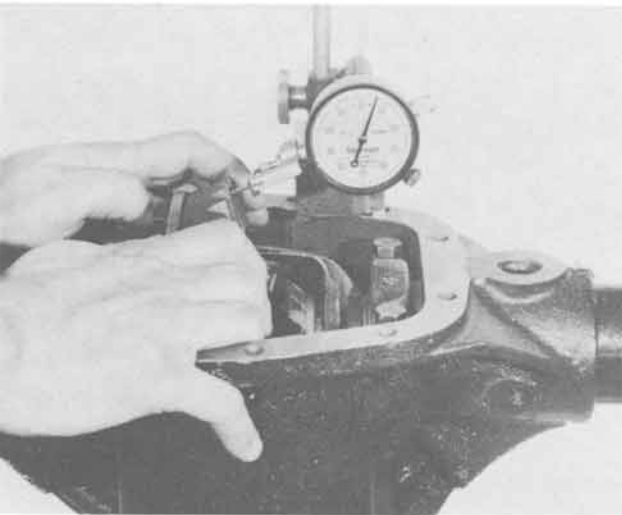


**Figure 153**

1008-153

Install new cover gasket and install cover plate. Torque screws to 15-25 lbs. ft.

Tool—C524-A Torque Wrench.



**Figure 152**

1008-152

Check ring gear and pinion backlash in three equally spaced points with dial indicator as shown.

Backlash tolerance is .005" to .008" and cannot vary more than .002 between points checked.

High backlash is corrected by moving the ring gear closer to the pinion.

Low backlash is corrected by moving the ring gear away from the pinion.

These corrections are made by switching shims from one side of the differential case to the other.

**WE SUPPORT  
VOLUNTARY MECHANIC  
CERTIFICATION  
THROUGH**



Dana Corporation, Spicer Axle Division, reserves the right to make changes from time to time, without notice or obligation, in specifications, descriptions, and illustrations, and to discontinue models or revise designs.

Questions regarding this manual should be directed to:

Spicer Axle Division  
Dana Corporation  
P.O. Box 1209  
Fort Wayne, Indiana 46801  
Attention: Engineering Technical Service Dept.